

Ki Pro GO2

File Based Recorder/Player



Installation and Operation Guide

Version 5.0
Published July 5, 2024



Notices

Trademarks

AJA® and Because it matters.® are registered trademarks of AJA Video Systems, Inc. for use with most AJA products. AJA™ is a trademark of AJA Video Systems, Inc. for use with recorder, router, software and camera products. Because it matters.™ is a trademark of AJA Video Systems, Inc. for use with camera products.

Corvid Ultra®, Io®, Ki Pro®, KONA®, KUMO®, ROI® and T-Tap® are registered trademarks of AJA Video Systems, Inc.

AJA Control Room™, KiStor™, Science of the Beautiful™, TruScale™, V2Analog™ and V2Digital™ are trademarks of AJA Video Systems, Inc.

All other trademarks are the property of their respective owners.

Copyright

Copyright © 2024 AJA Video Systems, Inc. All rights reserved. All information in this manual is subject to change without notice. No part of the document may be reproduced or transmitted in any form, or by any means, electronic or mechanical, including photocopying or recording, without the express written permission of AJA Video Systems, Inc.

Contacting AJA Technical Support or Sales

Please have all pertinent information at hand prior to contacting AJA support or sales.

Support Telephone: +1.530.271.3190

Support Website: <https://www.aja.com/support/contact>

Support Email: support@aja.com

Sales Email: sales@aja.com

Shipping Address: AJA Video Systems
180 Litton Drive
Grass Valley, CA 95945, USA

Contents

Notices	2
Trademarks	2
Copyright	2
Contacting AJA Technical Support or Sales	2
Chapter 1 – Introduction	5
Overview	5
Features	5
Media Storage	6
USB Media Formatting Requirements	6
SMB Support	7
H.264 File Compatibility	7
Ki Pro GO2 REST API Documentation	8
In This Manual	8
Chapter 2 – Ki Pro GO2 at a Glance	9
Front Panel	9
USB Media Ports	9
High Resolution LCD Display	10
Transport Control Buttons	12
Power ON/OFF Button	13
Headphone Jack and Volume Knob	13
Rear Panel	14
Ref Loop	14
SDI Inputs	14
SDI Channel Outputs	14
HDMI Inputs	15
SDI Monitor Out	15
HDMI Monitor Out	15
Balanced Analog Audio Inputs	16
Unbalanced Analog Audio Monitor Outputs	16
Ethernet Connector	16
Power Connector	16
Chapter 3 – Ki Pro GO2 Installation	17
Overview	17
What's In The Box?	17
Hardware Installation	17
Ki Pro GO2 Handle Installation	17
Optional Ki Pro Shelf	18
Applying Power	19
Using AC Power	19
Using DC Power	19
Remote Network Control	19
Direct Connection	20
LAN Connection	20
Chapter 4 – Front Panel Operation	22
Overview	22
Overlay Display Content	22
Basic Recording and Playback	26
Recording Clips With The Front Panel	26
Playing a Clip With the Front Panel	28
CONFIG Menus	29
CONFIG Menu Parameters	29
MEDIA Menus	36
MEDIA Menu Parameters	37
Chapter 5 – Browser Remote Control	43

Overview	43
Ki Pro GO2 Web UI Description	43
Ki Pro GO2 Web UI Screens	45
Status Screen	45
Config Screen	46
Media Screen	47
Group Screen	48
Presets Screen	50
Network Panel	51
Firmware Screen	52
Playlists Screen	54
Appendix A – Specifications	56
Ki Pro GO2 Tech Specs	56
Ki Pro GO2 Encoding Parameters	59
Entropy Encoding	59
I/P Frame Structure (GOP Length)	59
Bit Depth and Sampling	59
H.264 / H.265 and Bitrates	59
Ki Pro GO2 Dimensions	61
Appendix B – Safety and Compliance	64
3 Year Warranty and Liability Information	73
AJA Software License Agreement	74
Index	77

Chapter 1 – Introduction



Overview

AJA's Ki Pro GO2 is a portable genlock free, multi-channel H.264/H.265 HD and SD redundant recorder/player. Ki Pro GO2 records pristine quality video to off-the-shelf USB media. The flexible architecture of Ki Pro GO2 is designed for live production, sports, corporate events, training, houses of worship and more.

Ki Pro GO2 combines the Ki Pro family's intuitive design, flexibility and high quality with encoding/decoding of H.264/H.265 recording and playback in a compact 2RU, half-rack width form factor. Users can easily record up to four channels of HD and SD content from SDI and HDMI sources to standard USB media, and/or to SMB-based network storage. Genlock free recording eliminates the need to synchronize four input sources, while redundant recording provides multiple back ups in the field to protect the recorded video. Four 3G-SDI and four HDMI ports ensure a high quality source with standard cabling compatibility options. HDMI and SDI multi-channel monitoring enables Ki Pro GO2 to display up to four channels of video as a matrix monitoring output on one HDMI and/or SDI monitor.

Ki Pro GO2 also provides the ability to independently map any physical input to non-physical channels for recording, and to also provide an individual independent back up recording for every individual primary recording.

Designed to be either portable or rack-mountable with half rack wide 2RU high dimensions, Ki Pro GO2 is well suited for use in studio/truck environments in addition to on-set and even digital signage applications.

Menus and images are beautifully rendered on a high resolution front panel LCD display enabling detailed playback and monitoring in all environments. Ki Pro GO2 also supports remote operation over a network using a web browser or via its REST API.

Features

- Multi-channel recording of H.264 or H.265 clips
- 5 x USB recording media ports, compatible with off-the-shelf USB media
- Supports recording and playback to and from Network Attached Storage (NAS) using the Service Message Block (SMB) protocol
- Redundant recording
- Genlock free inputs

- 3G-SDI input (4x BNC connectors)
- 3G-SDI output (4x BNC connectors)
- HDMI v1.4a input (4x HDMI type A connectors)
- 2-channel embedded audio per video input
- Physical input matrix channel mapping
- 3G-SDI monitor output (1x BNC connector)
- HDMI v1.4a monitor output (1x HDMI type A connector)
- HDMI and SDI multi-channel matrix monitoring
- Five different High Variable Bit Rate (VBR) Recording Profiles
- Two balanced XLR analog audio inputs, mic/line/48v switchable (compatible with LTC)
- Single-channel clip playback
- Easy-to-use web UI, compatible with standard web browsers
- Front panel button controls with integrated HD resolution screen
- Appliance operation: Ki Pro GO2 does not require a host PC to setup or operate.
- RCA Audio output (2x mono RCA connectors)
- Headphone jack (1x 3.5mm Jack)
- 10/100/1000 Ethernet LAN (1x RJ-45 connector)
- Internal web server for remote control configuration via LAN
- 2RU, Half-rack Form factor
- Dual 12 Volt AC/DC power (2x 4-pin XLR connectors)
- 20 Preset registers for storing and recalling system preset configurations
- Alarms to alert users to conditions that may need attention

CAUTION: *This device contains a lithium battery. If you ever dispose of this device, ensure you follow local regulations for safe disposal. The lithium battery shall not be exposed to excessive heat, such as sunshine or fire.*

Media Storage

Ki Pro GO2 supports commonly available USB drives for economical media storage. In addition, Ki Pro GO2 supports network attached storage (NAS) using SMB.

USB Media Formatting Requirements

Ki Pro GO2 can store files on USB media in the following file systems:

- exFAT (default format)
- FAT32
- FAT16

NOTE: AJA recommends using and/or formatting to exFAT for best results due to file size constraints of FAT32 and FAT16.

Newly purchased USB media is usually pre-formatted by the manufacturer before shipment.

Supported USB Media

The USB media you use should be high quality, and have a speed rating appropriate for your recording and playback requirements. AJA has tested selected USB media, and the current list of these products is available at:

<https://www.aja.com/products/ki-pro-go#support>

SMB Support

Network Attached Storage (NAS) using SMB (Server Message Block) protocol is available for both recording and playback, supporting SMB versions 3.1.1, 3.0.2, 3.0, 2.1, or 2.0.

Ki Pro GO2 is able to record to a storage location on a network, and playback from that location, using SMB when it is connected to an SMB Server via GigE. The storage system (the SMB Server) will have a number of volumes on it, each of which contain a number of folders. Ki Pro GO2 records into a folder (called the Network Record Folder) located inside a Shared Folder located on one those volumes (see [Figure 1](#)).

Figure 1. SMB Network Recording

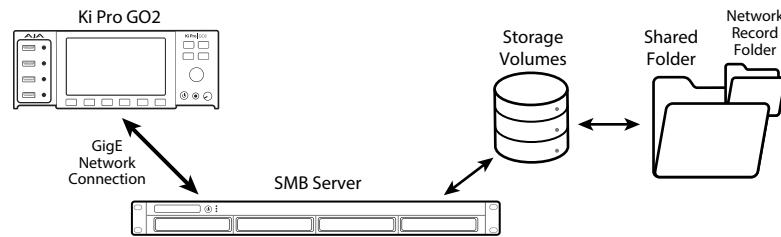

Before you can use an SMB Server for recording with Ki Pro GO2, you must tell the Ki Pro GO2 the path to the shared folder, and you can also define a path to a sub-folder in that Shared Folder into which files will be record or played back. See ["32.5 SMB Server and Share" on page 40](#) for more information.

H.264 File Compatibility

Ki Pro GO2 is capable of playing back H.264 files created by common 3rd party applications. This capability has been tested with the following applications:

- DaVinci Resolve
- Final Cut Pro X
- Avid Media Composer
- Adobe Premiere
- VLC (Windows)
- VLC (Macintosh) - The VLC file extension will need to be changed from "MV4" to "mp4."

Other applications may produce files that can also be played back by Ki Pro GO2, but AJA has only tested this capability with the above applications. Playback of media files created by other applications is not guaranteed.

Ki Pro GO2 REST API Documentation

AJA's REST automation API provides a platform from which you can issue commands to an AJA device, allowing remote systems the ability to control AJA embedded or networked devices. With this control framework, you can build integration and automation scripts, using any scripting language, allowing you to take full advantage of the device's functionality.

This documentation is available at the following link:

<https://www.aja.com/support/rest-api>

In This Manual

Chapter 1 provides an overview of hardware and software features and options.

Chapter 2 gets you started with Ki Pro GO2, introducing the front panel controls and rear connector features.

Chapter 3 gives detailed installation information.

Chapter 4 provides instructions for operating the Ki Pro GO2 from the front-panel controls and LCD display.

Chapter 5 discusses remote web browser control of Ki Pro GO2 via Ethernet.

Appendix A lists specifications.

Appendix B provides safety and compliance information.

Chapter 2 – Ki Pro GO2 at a Glance

Front Panel

Figure 2. Ki Pro GO2 Front Panel



The Ki Pro GO2 front panel includes:

- Four USB 3.2 Gen 1 (5 Gbps) ports, with status LEDs
- Large LCD display, with video monitoring and menu and status overlays
- User Control Knob for menu navigation and adjusting parameters
- DISP, STATUS, CONFIG, and MEDIA menu access buttons
- FUNC button, for rapid configuration
- Transport controls
- Headphone volume control and headphone jack
- Power button

USB Media Ports

The four USB media ports on the front each receive standard pre-formatted USB media. A fifth USB media port is available on Ki Pro GO2's rear panel.

These five ports are USB 3.2 Gen 1 (5 Gbps), support 5V 1A max current per port, and are also compatible with the following standards:

- USB 2.0 (480 Mbps)
- USB 3.0 (5 Gbps)*
- USB 3.2 Gen1 (5 Gbps)*

*Also referred to as SuperSpeed USB

USB Port LED Status Indicators

The USB LEDs indicate the state of the media ports, and when it is safe to remove media from Ki Pro GO2.

- Off - No media is mounted or the inserted media is not usable. Media in that port (if present) cannot be used and can safely be removed.

- Green - Valid media has been inserted and is not currently being used for recording or playback. Media in that port should be safe to remove.
- Green Flashing - Media is mounted and playing back a clip. The media itself is probably safe to remove (no data loss will result), but removing the media will cause a playback error.
- Amber Flashing - Media is mounted and recording. Media should not be removed, as it will interrupt the recording.

CAUTION: Failure to properly mount or dismount media, or an unexpected loss of power while recording, can result in an unrecoverable data loss.

High Resolution LCD Display

The front panel LCD display can show a quad split of all four Ki Pro GO2 recording channels (*Figure 2 on page 9*). You can also choose one the channels to view full screen (*Figure 3*), using the UI Monitor Channel configuration parameter setting.

Figure 3. Ki Pro GO2 UI Single Channel Monitor Display



Various overlays are available for configuration menus and other information, accessed with the buttons on the right. Menu navigation and selection is accomplished with the User Control Knob.

DISP Button

Use the DISP button to toggle video overlay display modes. Sequential presses of the button cycles through the display modes:

1. No overlay – display is video monitor only
2. Top and bottom status overlay
3. Top and bottom status overlay plus small VU meters
4. Top and bottom status overlay plus small VU meters and larger headphone VU meter
5. Top, bottom, VU meters, and the last displayed status or configuration screen. That operating mode (Status, CONFIG or Media) will also automatically be selected, and that mode's front panel button will be highlighted.

User Control Knob

The User Control Knob on the right side of the Ki Pro GO2 front panel can be used to scroll through and select menu items. After scrolling to and high-lighting a menu item of interest, push the knob to select. To cancel a selected menu item, rotate the knob to highlight EXIT and push the knob in to return to the top level.

Figure 4. Ki Pro GO2 User Control Knob



When an active configuration menu is displayed, pressing and holding the knob will restore that menu's factory default setting.

When not in a configuration mode and media is mounted with clips available, you can use the User Control Knob to scroll through the clips on that media.

When alarms are displayed on the LCD screen, pressing and holding the knob for two seconds will clear any displayed record alarms that are no longer active.

STATUS Button

When it is not highlighted, you can press the STATUS button to display the status overlay. Status information includes video/audio inputs and formats (Chnl/Input tab screen), file encoding, record path, and file names (File/Encode tab screen) and alarm information (Alarms tab screen). After the STATUS button is pressed, the selector knob can be rotated to display these tab screens in sequence.

A blinking STATUS button indicates Alarms are present. Press the STATUS button to immediately display the Alarms tab, where any alarms or warnings will be reported. Inactive alarms can be cleared from the screen by pressing and holding the User Control Knob for two seconds.

When the STATUS button is highlighted, pressing STATUS hides the Status overlay.

CONFIG Button

When it is not highlighted, you can press CONFIG to access the CONFIG menu overlay. If the transport is active (video is playing or being recorded) you will be prompted to stop the transport by pressing the STOP button. Pressing CONFIG when it is highlighted will exit the CONFIG menu and return to the previously selected display.

Once in CONFIG mode, rotate the User Control Knob to scroll through the menu system, push the knob to enter a selected menu, rotate the knob to scroll through the menu selections, and then push the knob again to select that setting. To leave a menu, scroll to Exit and press the knob. Pressing and holding the button in restores the factory default setting for that menu.

MEDIA Button

When it is not highlighted, you can press the MEDIA button to enter the MEDIA menu overlay. If the transport is active (video is playing or being recorded) you will be prompted to stop the transport by pressing the STOP button. Pressing MEDIA when it is highlighted will exit the MEDIA menu and return to the previously selected display.

Once in MEDIA mode, rotate the User Control Knob to scroll through the menu system, push the knob to enter a selected menu, rotate the knob to scroll through the menu selections, and then push the knob again to select that setting. To leave a menu, scroll to Exit and press the knob. Pressing and holding the button in restores the factory default setting for that menu.

VU Meters

Figure 5. Audio Meters Front Panel Display Example



Screen overlays are provided on the LCD to display audio VU meters. Meters are color coded to report signal strength:

- Green - audio source signal level is in the “safe” area (no clipping). The signal strength is also shown vertically, so you can see if the signal level is low. Generally, it’s preferred to have the signal near the top of the green or even occasionally peaking into the yellow.
- Yellow - audio source signal levels are at the peak edge of the safe area before clipping will occur.
- Red - audio source amplitude is too hot and the signal is clipping at its signal peaks. You should reduce the input gain at its source (camera, mixer or source equipment supplying the signal).

A large audio VU meter is available to display the level for the Ki Pro GO2’s headphone audio. This meter can be shown or hidden by pressing the front panel Display button.

You can also display smaller audio meters for the first two channels of each recording channel, by pressing the front panel Display button.

FUNC Button

The FUNC button can be configured to either directly access the Playback Media Source menu, or be disabled.

Transport Control Buttons

The transport buttons are always active, except during actual recording when only the STOP button can be used.

STOP - The square symbol STOP button has a dual function. When playing back a clip (PLAY, FFWD, or REV) the first push of STOP pauses the playback. When paused, the current frame of the clip is displayed as a still, and the STOP button flashes indicating that clip is paused. A second push of STOP stops the playback. The STOP button is fully illuminated in stop mode.

PLAY > - Press PLAY to begin forward playback of the current clip at normal speed.

RECORD - Press the round red RECORD button to begin recording. Once in RECORD mode, all other transport buttons are locked-out except the STOP button.

FFWD >> - Press FFWD to begin fast playback of the current clip at 2x speed. Successive pushes increase the speed to 4x, 8x, and 16x. (Pushing the button after 16x speed is reached has no further effect.) When fast-forwarding, audio is muted.

REV << - Press REV when not highlighted to begin playback of the current clip in reverse at 1x speed. Successive pushes increase the speed to 2x, 4x, 8x, and 16x. (Pushing the button after 16x speed is reached has no further effect.) When playing in reverse, audio is muted for all speeds.

Power ON/OFF Button

Press the Power button to turn Ki Pro GO2 power On and Off. When power is On the button is illuminated.

NOTE: When power is first applied to Ki Pro GO2, the unit powers up immediately (without pressing the button). This facilitates a quick return to operation if there is a power interruption.

In normal operation to turn power on, press the button once. Pressing the button will begin power-up and display start-up progress on the front panel display.

To power down, press and hold the power button down for three seconds (the display will count down). This process prevents accidental power-off during normal operation. You can abort the power-down process by simply removing your finger from the power button before the three seconds have elapsed.

Headphone Jack and Volume Knob

1/8" (3.5mm) miniature stereo TRS connection is available for standard stereo headphones.

To adjust headphone listening level, press the volume knob in and the knob will pop out for easy adjustment. After adjustment, you can press the knob back in to reduce the chance of accidental headphone level changes.

Rear Panel

Figure 6. Ki Pro GO2 Rear Panel

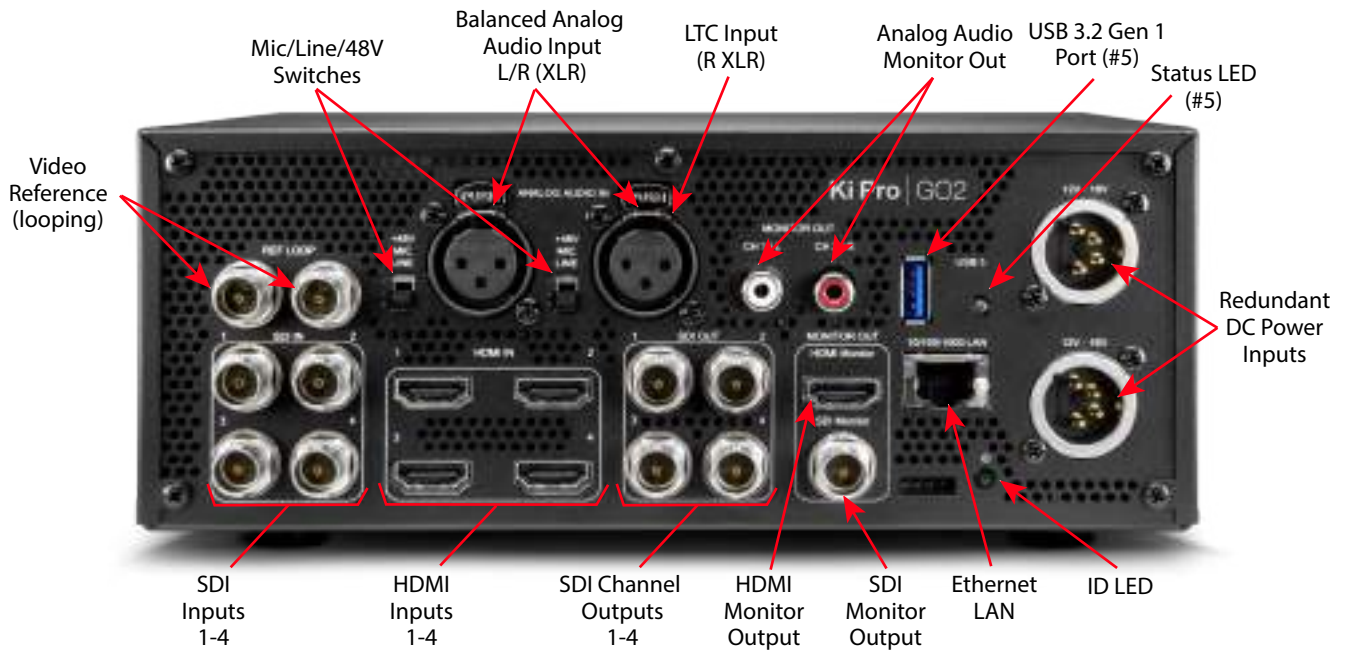

Ref Loop

The Reference Loop BNCs accept a reference timing signal. Incoming video sources do not have to be genlocked due to Ki Pro GO2's input frame syncs.

The reference, if used, can be analog SD blackburst or HD tri-level sync. The two BNCs are a passive loop: one BNC is for the Input, and the remaining BNC can be connected to another piece of equipment in the reference chain or terminated.

NOTE: For proper operation the input reference signal must be stable and properly terminated using a 75-ohm terminator on either the unused loop connector or the last piece of downstream equipment to which the reference video is connected.

SDI Inputs

Four input BNC connectors are provided, each supporting 3G-SDI video up to 1080p 60, and each accepts the first two channels of embedded 24-bit digital audio. Only single link SDI video is supported.

Each input can be routed to any or all of the four Ki Pro GO2 recording channels. Up to four video inputs can be recorded as clips at the same time.

Two channels of audio, RP-188 timecode, and VPID are preserved. All other ANC data will be lost.

SDI Channel Outputs

Four output BNC connectors are available, each supporting 3G-SDI video up to 1080p 60, and includes two channels of embedded 24-bit digital audio.

Each numbered SDI output BNC is linked one-to-one to each of the four Ki Pro GO2's recording/playback channels' output. Because the SDI (and HDMI) input signals can be routed, the SDI output BNC s not necessarily associated with the similarly numbered SDI input BNC.

During clip playback, all four SDI Channel output BNCs will carry the same video and audio signals of that playing clip.

IMPORTANT: During recording, an SDI BNC output signal is not a pass-through E-to-E signal of the input, and is not necessarily linked to the same numbered SDI input BNC connector.

During clip recording, a delay exists between the each of the Ki Pro GO2s' video input and output signals:

- Three frames at 23.98, 24, 25, 29.97, 30
- Six frames at 50, 59.94, 60
- The Ki Pro GO2 output will also add/drop frames if the input is not aligned with the sync source.

RP-188 timecode and VPID are preserved by re-inserting on the output, but all other ANC data will be lost. Embedded audio can be preserved and re-inserted on the output. Audio is sample-rate-converted prior to re-insertion.

NOTE: Which two audio channels are embedded into each SDI Output is determined by the audio embedding settings being used for that Ki Pro GO2 recording channel audio input setting, to either follow the video input's embedded audio or embed the analog audio inputs.

HDMI Inputs

Four full size input HDMI connectors are provided, each supporting 3G-SDI video up to 1080p 60, and each accepts the first two channels of embedded digital audio.

Ki Pro GO2 accepts 32 kHz, 44.1 kHz, and 48 kHz sample rate HDMI embedded audio, and converts it to 48 kHz internally.

Each input can be routed to any or all of the four Ki Pro GO2 recording channels. Up to four video inputs can be recorded as clips at the same time.

NOTE: When using the Ki Pro GO2 HDMI connection and attaching it to any HDMI audio or video accessory, you must use a ferrite-beaded HDMI cable, HH-28F-06, between the HDMI output port of the Ki Pro GO2 and the HDMI accessory to maintain regulatory compliance.

SDI Monitor Out

One SDI Monitor Out BNC connector allows monitoring the video and embedded audio output of one or all of the Ki Pro GO2's recording/playback channels. Which channel(s) are monitored is determined by the setting of the SDI Monitor Channel parameter. System timecode is also embedded in this output.

HDMI Monitor Out

One full size HDMI Monitor Out connector allows monitoring the video and embedded audio output of one or all four of the Ki Pro GO2's recording/playback channels. Which channel(s) are monitored is determined by the setting of the HDMI Monitor Channel parameter.

Balanced Analog Audio Inputs

Two XLR connectors provide Mic/Line/48V analog audio input, which can be routed to any or all of the Ki Pro GO2 recording channels. The right audio input channel also supports LTC input, in which case the level selector switch should be set to Line.

Unbalanced Analog Audio Monitor Outputs

Two RCA connectors provide line level analog audio output, carrying the same signal sent to the front panel headphone output.

Ethernet Connector

An RJ-45 connector provides a 10/100/1000 Ethernet port for connecting Ki Pro GO2 directly to a computer, or to a hub or switch for connection to a LAN, allowing Ki Pro GO2 remote control and configuration. In addition this network connector can be used for SMB-based NAS recording and playback.

Ki Pro GO2 is compatible with CAT-5e or CAT-6 straight-through or cross-over Ethernet cables, automatically detecting which is used. Once connected and properly configured, Ki Pro GO2 can then be controlled by a web browser on the LAN.

Power Connector

On the back of Ki Pro GO2 are two standard 4-pin male XLR connectors for supplying 12-Volt DC power to the unit. You can use either the supplied AC Adapter or furnish your own battery source. Since the connector is an industry standard pinout, choices are varied and flexible. Many 3rd party vendors offer products using this standardized power connector.

- Pin 1: -
- Pin 4: +
- Pins 2 and 3: not used

Chapter 3 – Ki Pro GO2 Installation

Overview

Ki Pro GO2 can be used on a desktop by simply connecting power, video and audio inputs and outputs, and inserting USB media. Front panel controls allow Ki Pro GO2 configuration, and record and play functions.

Ki Pro GO2 also supports remote web control via Ethernet, once configured for network operation.

What's In The Box?

When you unpack your Ki Pro GO2, you'll find the following components:

- Ki Pro GO2 Recorder
- AC Adapter 110/220 with industry standard 4-pin XLR connector for powering the Ki Pro GO2. A standard North American line cord with 3-prong plug is included.
- Handle Installation Kit

Please save all packaging for shipping the Ki Pro GO2 should you need to do so.

Hardware Installation

Ki Pro GO2 Handle Installation

For units that will be moved often, AJA provides a sturdy handle.

Figure 7. Ki Pro GO2 with Handle Installed



Figure 8. Ki Pro GO2 Handle Assembly

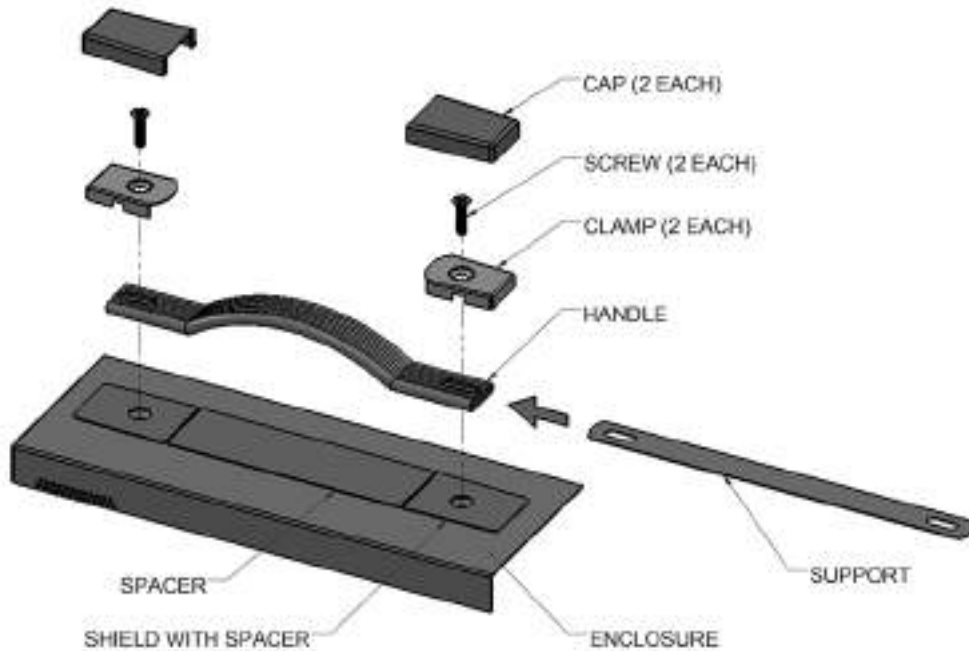

1. Remove the two screws from the right side of the enclosure and keep for reuse.
2. Place the Shield with Spacer (temporary) on top of the Enclosure, aligning the holes.
3. Slide the Support into the Handle.
4. Place the Handle on top of the Shield, aligning the holes.
5. Place the Clamps on top of the Handle, aligning the holes.
6. Insert the two screws through the Clamps, Handle, Support, and Shield and into the enclosure.
7. Snap the Caps over the Clamps and tear away the Spacer from the Shield.

Optional Ki Pro Shelf

AJA offers this rack-mount shelf accepting two Ki Pro units in a 2RU footprint. For example, in the same rack you can mount two Ki Pro GO2s to simultaneously record eight sources, or you can mount a Ki Pro Ultra 12G and a Ki Pro GO2, which allows simultaneous recording of high resolution .MOV or .DNX files, as well as separate compressed .MP4 clips for immediate delivery to a client or for direct use as proxy media for post production.

Figure 9. Ki Pro GO2 mounted in Rackmount Shelf with a Ki Pro Ultra 12G.



NOTE: The AJA part number for the optional Ki Pro Shelf is "KPU-SHELF." Please check with your AJA reseller for pricing and availability.

Applying Power

Using AC Power

To begin using Ki Pro GO2, plug the 4-pin XLR on the supplied AC adapter into the XLR power socket on the rear of Ki Pro GO2. Then plug the AC adapter line cord into 110 VAC or 230 VAC (the supply is auto sensing). Two power supplies can be used for redundancy.

NOTE: When connected to power, Ki Pro GO2 will immediately begin the power-up procedure. This automatic start-up allows the unit to return to operation as soon as an unexpected power interruption is corrected.

Figure 10. Ki Pro GO2 Power Supply Connections



Using DC Power

To run Ki Pro GO2 on DC power, plug a 3rd-party industry standard 12 Volt battery pack with a 4-pin female XLR connector into the power connector on rear of the Ki Pro GO2. The battery should be capable of supplying a sustained 3.3 A (as is supplied by the AC Adapter provided). Battery packs are available from a variety of sources.

NOTE: To operate Ki Pro GO2 properly, batteries should not have voltage lower than 12 volts and should not have voltage that exceeds 18 volts.

Ki Pro GO2 is a low-wattage device so many batteries can power it for several hours at a time. Ki Pro GO2 displays a “Low Battery” warning prompt to help you stop recording before battery failure. We also recommend the use of batteries with metering or remaining power indications. Two batteries can be used for redundancy, which can be swapped for power of unlimited duration, only limited by the number of charged batteries on hand.

Remote Network Control

Ki Pro GO2 can be controlled by a computer using a single CAT-5e or CAT-6 Ethernet cable (straight or cross-over), or by using an Ethernet 10/100/1000 local area network (LAN) connection to Ki Pro GO2’s Ethernet RJ-45 connector.

An optimized web server running on Ki Pro GO2 allows you to remotely monitor and adjust parameter settings via a browser client running on a connected computer.

NOTE: Exposing Ki Pro GO2 on a broadband WAN is not generally recommended since anyone on the Internet could potentially access Ki Pro GO2.

The LAN connection on Ki Pro GO2 is internally intelligent and communicates via standard "straight-through" CAT Ethernet cables or null-modem (cross-over) cables without any configuration or strapping required.

Direct Connection

You may be able to control it by simply connecting it to a Mac or PC using one RJ-45 cable.

Figure 11. Ki Pro GO2 LAN Connection Example, Direct to Laptop

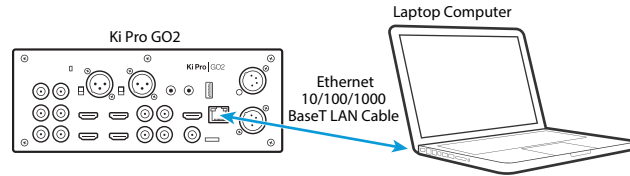

Direct Connect Procedure

1. Connect Ki Pro GO2 to your computer with a CAT Ethernet cable.
2. Press the Ki Pro GO2 front panel **CONFIG** button to show the Configuration menus on the front panel display.
3. Go to the IP Address Type menu and ensure that **Static** is selected in the Ki Pro GO2's IP Address Type menu, then go to the Address menu and enter the static address you wish to use for the Ki Pro GO2.
4. Set a compatible static IP address on the PC, and you're good to go.
5. Go to the Ki Pro GO2 **IP Address** menu, note the IP address displayed, and enter that IP address into that computer's web browser.
6. The Ki Pro GO2 webpage will be displayed, allowing complete control of the unit.

LAN Connection

A LAN is a shared network that includes other Ethernet devices all attached via a hub or switch. Multiple computers on the network will then be able to control that Ki Pro GO2 by entering its IP address into each computer's web browser.

Figure 12. Ki Pro GO2 LAN Connection Example using a LAN

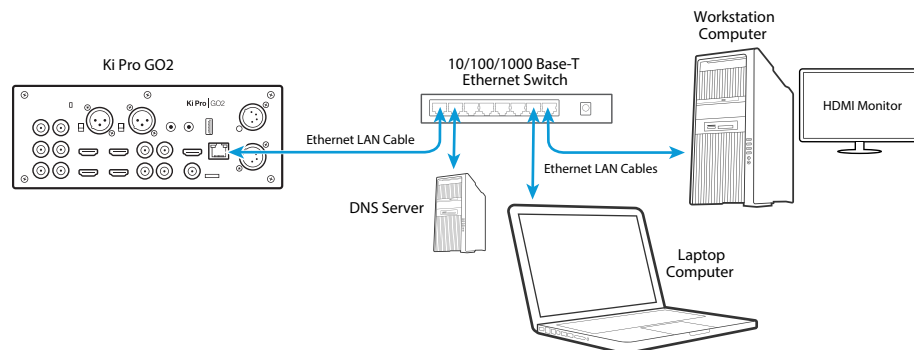

TCP/IP Information You May Need

LANs may be divided into zones, and devices on a LAN may have dynamically assigned (DHCP) IP addresses, or fixed (static) IP addresses. Before connecting Ki Pro GO2 to the LAN, talk to your network administrators to find out how they want it connected (DHCP or Static IP). If your LAN requires static IP addresses, also ask your IT administrator for the Subnet Mask and Default Gateway IP addresses (your LAN's Internet router).

LAN DHCP Configuration Procedure

Because Ki Pro GO2 ships configured by default for DHCP operation, it can automatically connect to a properly configured network.

1. Connect Ki Pro GO2 to a LAN hub or switch operating as part of a DHCP network, using a CAT Ethernet cable.
2. Connect a DHCP configured computer to the network using a CAT Ethernet cable.
3. Press the Ki Pro GO2 front panel **CONFIG** button to show the Configuration menus on its front panel display.
4. Go to the **IP Address Type** menu and ensure that **DHCP** is selected in the Ki Pro GO2's **IP Address Type** menu.
5. Go to the Ki Pro GO2 **IP Address** menu, note the IP address displayed, and enter that IP address into your computer's web browser.
6. The Ki Pro GO2 webpage will be displayed on your network connected computer's web browser, allowing complete control of the unit.

LAN Static IP Connection Procedure

This procedure assumes you will be using a computer that is already configured for use on the LAN.

1. Ask your network system administrator for the IP information the Ki Pro GO2 is required to use on that network.
2. Press the Ki Pro GO2 front panel **CONFIG** button to show the Configuration menus on the front panel display.
3. Ki Pro GO2 **IP Address Type** menu and select **Static Addr.**
4. Connect Ki Pro GO2 using a CAT Ethernet cable to a LAN hub or switch operating as part of a DHCP network.
5. Go to the Ki Pro GO2 **IP Address** menu and enter the IP address provided by your network system administrator.
6. If necessary, also go the Ki Pro GO2 **Subnet Mask** menu and the **Default Gateway** menu and enter the information provided by your network system administrator.
7. Power cycle the Ki Pro GO2.
8. After reboot, go to the Ki Pro GO2 **IP Address** menu, and note the IP address displayed.
9. Enter the Ki Pro GO2's IP address into your network connected computer's web browser.
10. The Ki Pro GO2 webpage will be displayed, allowing complete control of the unit.

See "[Chapter 5 Browser Remote Control](#)" on page 43 for more information.

Chapter 4 – Front Panel Operation



Overview

The simplest way to control Ki Pro GO2 is to use its front panel menu and controls. See "[Chapter 5 Browser Remote Control](#)" on page 43 for information about web browser operation.

Overlay Display Content

Ki Pro GO2's front panel display different information in various menu overlays.

Initial Overlay

On power up, Ki Pro GO2 initially overlays information at the top and bottom of the front panel menu screen.

Figure 13. Initial Display Overlay



Top Line

The top line displays:

- Ki Pro GO2 system name, or a red error message
- Current clip timecode
- Clip format

Bottom Line

The bottom line displays:

- Percentage of media capacity available for each port
- Currently selected media port and clip name

Three Display modes are accessed via the STATUS, CONFIG, and MEDIA buttons.

Status Menu Display

In the Status menu, the User Control Knob toggles between four tabs: Chnl/Input, File/Encode, SMB, and Alarms. These are Read-Only displays.

Chnl/Input Tab

Figure 14. Status Menu, Chnl/Input Tab.



This menu shows the configuration status of Ki Pro GO2's four recording and playback channels. Status information includes:

- Channel Enable
- Video and Audio Inputs
- Video Format

File/Encode Tab

Figure 15. Status Menu, File/Encode Tab.



This menu shows the configuration status of Ki Pro GO2's four channels.

SMB Tab

Figure 16. Status Menu, SMB Tab.



This menu shows the configuration status of Ki Pro GO2's SMB network recording.

Status information includes:

- Media State: (Mounted status is displayed as yellow text, while UnMounted or Error status is displayed in red text)
- SMB Server and Share:
- SMB Net Record Path:
- Domain Username:
- SMB Media Capacity:

Alarms Tab

Figure 17. Status Menu, Alarms Tab.



This menu reports warnings and alarms. Some alarms will automatically be shown on the top bar of the display. Others will be indicated by the STATUS button flashing.

Once a Ki Pro GO2 alarm is active, the STATUS button light will blink for as long as the alarm is present. This alerts you so you'll know the reasons for the alarm condition are still active. You can then check the Alarms display by pressing the STATUS button and using the User Control Knob to scroll to the Alarms tab.

If you enter the CONFIG or MEDIA menus after an alarm notification, the alarm display will go away. Pushing any button always returns Ki Pro GO2 to its pre-alarm state. However, if you are unable to correct the alarm condition after this initial button push, when you leave these menus, the alarm notification will reappear on the display. These persistent alarm reminders are intended to keep you aware of situations that could prevent a successful recording. In addition, alarms that have been resolved, as a rule, are not automatically cleared from the alarm display, to help you determine possible causes for the problem (for example, an unreliable SDI cable). You can clear resolved alarms from the menu by pressing and holding the User Control Knob for two seconds.

Ki Pro GO2 features a variety of alarms to help you diagnose the condition of the unit, possible configuration issues, or possible signal issues.

Warning: Media Unformatted - May appear if Ki Pro GO2 does not recognize the file system on the media or the media has never been formatted.

Warning: Media Low - Appears when the media only has 10% of capacity remaining.

Warning: Media Full - Appears when only 1% of media capacity remains. Recording will continue, however, until the media is completely filled.

Warning: Dropped Frames - May appear if media is under-performing and cannot keep up with the data rate required to make a recording or perform a playback. If you see this prompt during recording, recordings will stop. If this prompt appears, you might consider backing up your current recordings and formatting the media. For playback, you might simply re-attempt playback.

Warning: Input Format Changed- This prompt appears if a recording is started and the signal is lost or changed. If this occurs, Ki Pro GO2 stops the recording that is in progress (unless the Loss of Video CONFIG menu parameter is set to continue recording.)

Warning: No Video Input - May appear if there is no video input to Ki Pro GO2. No recording will be performed in this state.

Warning: Genlock Missing - Appears if you choose "Input" or "Ref In" for Genlock and you attempt to play a clip and no genlock is detected on the selected input.

Warning: Recording will end - Appears four minutes before the Record Minutes Max time is expired, and is a warning only.

Warning: Recording minutes max reached - Appears when the recording has been stopped because the time has expired. It clears the "Recording will end" alarm.

Warning: Recording failed - This alarm announces several failure conditions, each indicated by an error message within the alarm.

Warning: SMB Share Unsupported

Warning: SMB Share Too Slow - Underperformance when writing to SMB (recording) will cause that write to be terminated. Underperformance when reading from the SMB Share (playback) will result in AV sync issues which worsen over time.

Warning: SMB Share Not Mounted

Warning: SMB Share Destination Insecure - The SMB storage destination is connected to a remote file share using SMB Version 1.0, which is insecure and should not be used because it can expose network usernames and passwords to attackers. SMB version 2.0 or higher should be used instead in the Recording Profiles menu.

Warning: SMB Storage Low - SMB Share is 90% full - consider replacing media.

Warning: SMB Storage Full - SMB Share is 90% full - replace or format to continue.

Warning: SMB Share Failed to Mount - Check login credentials and connection settings.

Warning: SMB Share Write Protected - Cannot write to the mounted SMB Share. Check server settings or login credentials.

CONFIG and MEDIA Displays

In the CONFIG and MEDIA menus, the User Control Knob scrolls through various adjustable parameters, and pressing the knob activates menu field for scrolling through the choices (yellow outline indicates the field is active). When entering a menu, the system remembers and returns to the last selected parameter.

Figure 18. Example CONFIG Menu, Enable Channel



Figure 19. Example MEDIA Menu, Channel Clip Name



Basic Recording and Playback

Recording Clips With The Front Panel

NOTE: To help insure successful recording with Ki Pro GO2 it is good practice to use new, high-quality media that has been freshly formatted.

Routing Video and Audio Inputs

Any SDI or HDMI video input can be routed to any or all of the Ki Pro GO2's recording channels. Factory default assignment is one-to-one: SDI 1-4 inputs to Ki Pro GO2 recording channels 1-4 (USB ports 1-4).

- If different video routing is desired, press the **CONFIG** button, scroll to each **Video Input** menu, and select the desired video input source for each channel (choose one from **SDI 1 -4**, **HDMI 1-4**).
- If you wish to record audio from the Ki Pro GO2's analog inputs instead of the audio embedded in video input selected above, scroll to the desired **Audio Input** menu, and select **Analog**.

Recording Clips

1. Route the desired input video and audio to your recording channels (see above).
2. Prepare your recording media:
 - A. For USB media, insert compatible pre-formatted USB media into the desired Ki Pro GO2 front panel USB ports.
 - B. For SMB, enter the parameters of a currently configured and available NAS (SMB Server and Share, SMB Network Record Path, SMB Dialect, Domain, Domain Username and Password).
3. Press the STATUS button. You can then scroll through the Status menus to see the current recording parameters.
4. The factory default setting enables recording to all four Ki Pro GO2 front panel USB ports. If you wish to record fewer channels, you can press CONFIG, go to the appropriate **Enable Channel** menus, and select **Disable** for the undesired channels.
5. You can adjust the recording quality level performed by each Ki Pro GO2 channel by pressing **MEDIA**, going to the appropriate **Channel Encode Quality** menus, and choose the quality level, ranging from **Low** to **High**.
6. When these Ki Pro GO2 settings are acceptable, simply push the red **RECORD** button below the display. If using USB media, the port LED indicators will blink indicating recording is in progress. The clip time will be updated on the UI display during record.
7. Press the **STOP** button to finish the recording. The clip will be stored on that media with a generated file name specified in the MEDIA menus.

See "[21.0 Channel 1 Clip Name](#)" on page 38 for information about clip naming.

Recording Backup Clips

A separate backup recording can also be created for each clip. This example uses USB Port 5, but backup recordings can be saved to any Ki Pro GO2 USB port or a configured NAS.

1. Insert compatible pre-formatted USB media into the rear panel Ki Pro GO2 USB port 5.
2. Before initiating the recording, press **MEDIA** and scroll to each desired **Channel # Backup Rec Dest** menu and select **USB Port 5**.
3. Perform the desired recording on your Ki Pro GO2. Each clip recording will then also record a backup file onto the USB media mounted in port 5.

Backup recordings will have the same file name as its primary clip, with "_bak" appended to the name.

Media Recording Capacity

NOTE: When selecting your USB 5 backup media, please check the Ki Pro GO2: Approved Media List Document found here: <https://www.aja.com/products/ki-pro-go#support>.

Ki Pro GO2 alerts you when the media is nearly full with a “Media Low” prompt at 10% of the remaining capacity. At 1% of the total capacity of the media, the “Media Full” prompt will appear. Recording will continue, however, until the media is completely filled.

To re-enable recording onto completely filled media, use a computer or other external device to delete clips from the media, or completely reformat it (which erases all the data on that media).

Playing a Clip With the Front Panel

Ki Pro GO2 supports the playback of one clip at a time. Video for that clip is sent simultaneously to all four SDI BNC output connectors (even disabled channels), and also to the SDI monitor output and to the HDMI monitor output.

Select, Cue and Play a Clip

1. Press the **STOP** button if a clip is playing.
2. Press **MEDIA**, scroll to the **Playback Media Source** menu and select the USB port (USB 1, 2, 3, 4, or 5) mounted with media that contains the desired clip.
3. Turn the User Control Knob until you find the desired clip on that media. The selected clip file name is shown on the bottom right of the menu.
4. Use the Ki Pro GO2's front panel transport controls to cue the clip to its desired start point.
5. Press the **PLAY** transport button. The clip will play from its cued location.

When playing back a clip, the first push of **STOP** pauses the clip. The current location of the clip is displayed on the Ki Pro GO2's outputs, and the **STOP** button will flash. A second push of **STOP** completely stops the playback.

Clip or All Playback

You can control whether a single clip or all clips on the currently selected media will be played with a single press of the **PLAY** transport button. Multiple clips play back in the order that they reside on the media.

1. Select and cue the desired clip (see above).
2. Press **MEDIA**, scroll to the **Playback Type** menu, and set the desired playback type.
 - **Clip** - Will play only the selected clip (stopping or looping at its end point depending on the setting for Loop Playback). When done, the playing clip is paused, and a still image of the last frame will be output.
 - **All** - Plays the selected clip, and then cues and plays following clips on that media in sequence (stopping or looping depending on the setting for Loop Playback). When done, the last playing clip is paused, and a still image of the last frame will be output.

NOTE: Ki Pro GO2 attempts to make the transitions between multiple clip playback as clean as possible, but some momentary distortion may occur depending on the types of clips being played. For example, transitions between H.264 and H.265 clips will have distortion.

3. Press the **PLAY** button. The clip(s) will play as specified.

- When playing back a clip (PLAY, FFWD, or REV) the first push of STOP enables a "Pause" mode. Playback is paused, the current frame of the clip is displayed, and the STOP button flashes. A second push of STOP completely stops the playback.

The Playback Type setting remains in force until it is changed in the MEDIA menu.

Loop Playback

You can control whether a clip or series of clips are played once, or are played back repeatedly.

- Select and cue the desired clip.
- Press **MEDIA**, scroll to the **Loop Playback** menu and set the desired manner of playback.
 - On** - Will play the selected clip to the end and repeat its playback from the beginning.
 - If **Clip** is selected above, only that individual clip will play repeatedly until stopped by the user.
 - If **All** is selected above, that clip and all the following clips will play in turn, and then repeat playback again in that sequence from the first clip played until stopped by the user.
 - Off** - Plays the selected clip, or all clips on that media, once through and then stops. When done, the last playing clip is paused, and a still image of the last frame will be output.
- Press the **PLAY** button. The clip(s) will play as specified.

The Loop Playback setting remains in force until it is changed in the MEDIA menu.

CONFIG Menus

The CONFIG menus provides controls that allow configuring various aspects of how Ki Pro GO2 operates.

CONFIG Menu Parameters

1.0 Enable Channel 1

Enables Channel 1 for clip recording and/or playback. When disabled that channel cannot not be used.

Enable (default) Disable	Channel 1 is enabled. Channel 1 is disabled.
-----------------------------	-------------------------------------------------

1.1 Video Input 1

Selects which SDI or HDMI video input will be routed to Ki Pro GO2 Channel 1.

SDI 1 (default is Ch#) SDI 2 SDI 3 SDI 4 HDMI 1 HDMI 2 HDMI 3 HDMI 4	Selects SDI 1 input video. Selects SDI 2 input video. Selects SDI 3 input video. Selects SDI 4 input video. Selects HDMI 1 input video. Selects HDMI 2 input video. Selects HDMI 3 input video. Selects HDMI 4 input video.
-------------------------------------------------------------------------------------------	--------------------------------------------------------------------------------------------------------------------------------------------------------------------------------------------------------------------------------------------------

1.2 Audio Input 1

Selects the audio input for Channel 1. You can select the first two channels of embedded audio from the incoming video signal, or the Ki Pro GO2's XLR Analog Input connectors.

Follows Video (default) Analog	Selects embedded audio from the incoming video signal. Selects analog audio input
-----------------------------------	--------------------------------------------------------------------------------------

2.0 - 4.2 Channel 2, 3, and 4 Input Settings

Same settings above for Ki Pro GO2 Channels 2, 3, and 4.

- 2.0 - 2.2 = Channel 2 menu numbers
- 3.0 - 3.2 = Channel 3 menu numbers
- 4.0 - 4.2 = Channel 4 menu numbers

5.0 Loss of Video

Controls Ki Pro GO2 behavior if the video routed to a channel is lost during recording. This setting affects all four channels. Video loss will be detected and an alarm message will be posted indicating that input video has been lost on specific channels.

Record Last Frame (default) Record Black.	The last good video frame is passed through the codec and continues to be recorded as a still image. Black will be recorded if video is lost.
----------------------------------------------	--------------------------------------------------------------------------------------------------------------------------------------------------

6.0 SDI Monitor Channel

Controls which channels are displayed on the SDI Monitor output.

Channel 1 Channel 2 Channel 3 Channel 4 All Channels (default)	Display only Channel 1. Display only Channel 2. Display only Channel 3. Display only Channel 4. Display all four channels in quadrants.
----------------------------------------------------------------------------	-----------------------------------------------------------------------------------------------------------------------------------------------------

6.1 HDMI Monitor Channel

Controls which channels are displayed by the HDMI Monitor output. Select from the same settings listed above.

6.2 UI Monitor Channel

Controls which channels are displayed by the built-in front panel LCD display. Select from the same settings listed above.

6.3 Headphone Audio

Selects which channel's audio is routed to the headphone output. This setting also affects the rear RCA audio monitor jacks and the front panel VU meters. Select from:

- Channel 1 (default), 2, 3, or 4

6.4 Super Out

This parameter provides an overlay of timecode and transport state (Record, Pause, etc.), audio meters and storage status onto the SDI monitor output. Note that Super Out applies only to the SDI and/or HDMI monitor outputs, not the 4x 3G-SDI or HDMI outputs. These other outputs are always "clean".

Off (default) SDI Monitor HDMI Monitor SDI/HDMI Monitor	Superimposition is disabled Superimposition is enabled for SDI Monitor output Superimposition is enabled for HDMI Monitor output Superimposition is enabled for SDI and HDMI Monitor output
------------------------------------------------------------------	------------------------------------------------------------------------------------------------------------------------------------------------------------------------------------------------------

6.5 Screen Overlay Opacity

This parameter adjusts the opacity of the Super Out and front panel Overlay displays.

- 100%
- 75% (default)
- 50%
- 25%

6.6 Time Code Size

This parameter adjusts the size of the Super Out time code displayed. Choose from:

- Normal TC Size (default)
- Large TC Size

7.0 3G SDI Level

This parameter allows the 3G SDI output to be configured for either Level A or Level B. While many 3G SDI devices will support both Level A and Level B, some devices may need a specific 3G SDI selection to operate as expected.

Level B (default) Level A	For use with devices that accept or require Level B. For use with devices that accept or require Level A.
------------------------------	--------------------------------------------------------------------------------------------------------------

7.1 HDMI/EDID Override

This parameter determines whether the HDMI Output is auto-negotiated with the receiving device via EDID (extended display identification data) or via a specified output type.

Auto (default) YCbCr RGB	The HDMI output is negotiated automatically with the receiving device via EDID. Configures the HDMI output for 10-bit YCbCr 422 Configures the HDMI output for 8-bit RGB
--------------------------------	--------------------------------------------------------------------------------------------------------------------------------------------------------------------------------

NOTE: Typically, you will want to simply leave the selection configured for Auto so that the negotiation between the devices is handled automatically.

7.2 Inter/PsF Override

This parameter defines the clip recording method used for interlaced or PsF input video. Ki Pro GO2 always records clips as progressive frames, so some type of conversion is required to record non-progressive frame input video.

For 23/24 fps material, interlaced input video can be assumed to have come from film with no time difference between the interlaced frames (PsF), making the conversion trivial. If the material is 25/29/30 fps, time differentiated interlaced frames are assumed to be present, in which case true de-interlacer processing is required for recording.

Auto (default)	Automatically selects the recording method, depending on the identified input format. Incoming video with frame rates of 23/24 are assumed to be PsF, and 25/29/30 sources are assumed to be interlaced, with each converted accordingly.
PsF	PsF sources are trivially converted to progressive for recording.
Interlaced	Interlaced sources are converted with a de-interlacer for recording.

7.3 Progressive Playback

This parameter defines the processing applied when progressive media is played from storage.

Progressive (default)	Clips are played back as standard progressive frame.
Interlaced	Clips are converted to interlaced video for playback.

7.4 Genlock Source

This parameter selects the source of reference to genlock to during idle, record and playback.

For general monitoring purposes, genlock is not required.

Freerun	Ki Pro GO2 syncs to its own timebase and is not locked to an external source.
Ref In	Use the Ref Input as the Genlock source.
Channel 1 (default)	Use the Channel 1 input as the Genlock source.
Channel 2	Use the Channel 2 input as the Genlock source.
Channel 3	Use the Channel 3 input as the Genlock source.
Channel 4	Use the Channel 4 input as the Genlock source.

7.5 Analog Audio

This parameter configures the analog audio signal levels for input and output.

+24dBu (default)	Selects pro-level USA signal levels of +24dBu
+18dBu	Selects pro-level Europe signal levels of +18dBu
+15dBu	Selects pro-level German signal levels of +15dBu
+12dBu	Selects consumer signal levels of +12dBu
	NOTE: Maximum amplitude (0 dBFS)

Professional audio equipment has much higher levels than consumer equipment: a 0 VU reading corresponds to +4 dBu. Connecting a professional +4 dBu device to a consumer audio input -10dBV (-7.8 dBu) may cause overloading, whereas the output of a consumer device probably does not have sufficient power to drive a professional audio input. With consumer and semi-professional audio equipment, a VU reading of 0 dB is typically referenced to -10 dBV. 0 dBu = 0.775 VRMS.

These settings are valid with the panel Mic/Line switch set to "Line." (The Mic settings are lower input level settings for use with condenser and dynamic microphones—use Mic +48 for powered condenser mics and Mic for dynamic microphones.)

About Ki Pro GO2 Timecode

Ki Pro GO2 always records timecode onto clips. The timecode can originate from an incoming SDI video's RP188 data, it can be recorded as the time of day, or it can be specified to start at a specific hour.

Ki Pro GO2 also plays video with timecode. If no timecode is present in a clip (it was recorded by another device), the clip playback timecode begins at 00:00:00:00, and these timecode values are also embedded as RP188 data on Ki Pro GO2's SDI outputs.

Drop-frame (DF) timecode was created to match time of day with fractional frame rate video (i.e. 29.97, 59.94), by dropping selected timecode numbers. Two timecode frame numbers are dropped every minute, on the minute, except every tenth minute. Note that actual video frames are not lost. Instead some of the timecode numbers assigned to video frames are skipped. Non-drop-frame (NDF) video gives each frame sequentially ascending timecode numbers without gaps.

For time of day timecode, Ki Pro GO2 detects frame rates and automatically selects NDF for even frame rate video, or DF for fractional frame rate video. For RP-188 embedded timecode, Ki Pro GO2 detects the embedded DF/NDF flag and uses it regardless of the frame rate or system setting.

8.0 Timecode In

Selects the source of the timecode to be recorded onto clips.

Timecode Value (default)	Timecode will be determined by the Timecode Value and Timecode Value Type parameters described below.
Time of Day	Uses the Ki Pro GO2's time setting (Date/Time parameter) for timecode. Drop frame depends on the incoming video. For example, a 25 fps input is written as NDF, and a 29.97 input is written as DF.
Channel 1, 2, 3, or 4	Uses that channel's incoming video RP188 timecode, if present. If RP188 is not present, the Timecode Value and Timecode Value Type parameters below will determine the recorded timecode.
LTC on Audio In	Uses incoming LTC timecode present on the audio input (R). For this use the level selector switch should be set to Line.

8.1 Timecode Value

When the Timecode In parameter is set to Timecode Value, the timecode of recorded clips will begin at the specified hour. Select from:

- 00:00:00:00 (default) to 23:00:00:00

This setting will also be used for timecode if incoming RP188 data is not present on the selected source.

8.2 Timecode Value Type

When the Timecode In parameter is set to Timecode Value, this parameter specifies recording either Non Drop Frame or Drop Frame timecode.

NDF (default) DF	Non-drop-frame timecode video will be recorded. Drop-frame timecode video will be recorded.
---------------------	------------------------------------------------------------------------------------------------

This setting will also be used for timecode if incoming RP188 data is not present on the selected source.

9.0 IP Address Type

This parameter determines the type of TCP/IP network configuration used by Ki Pro GO2.

DHCP (default)	Select automatic IP address assignment from a DHCP server. Ki Pro GO2 will attempt to find and connect to an existing DHCP network. If found, Ki Pro GO2 will acquire and use the IP address provided by the DHCP server. If DHCP fails the Ki Pro GO2 may be given a 169.254.<random>.<random> IP address.
Static Addr	Assign a static IP address manually. The default static IP address is 10.65.76.65.

NOTE: If DHCP is selected and a DHCP server is not found after 40 seconds, the Ki Pro GO2 will see if a 169.254.<a>. address already exists on the network. The <a>. values are derived from that Ki Pro GO2's unique serial number. If a match is not found, the Ki Pro GO2 will be configured with that IP address. If that IP address already exists on the network, Ki Pro GO2 will assign random <a>. values and repeat until a unique IP address is generated, and will use that IP address.

9.1 IP Address

This parameter determines the static IP address used by Ki Pro GO2 for TCP/IP networking.

NOTE: IP addresses consist of "octets" separated by a period (i.e., 10.0.181.0). To edit these, press the User Control Knob to access the alpha-numeric keyboard to enter the desired IP Address. When complete click the Save function.

9.2 Subnet Mask

This parameter determines the subnet mask used by Ki Pro GO2 for TCP/IP networking.

9.3 Default Gateway

This parameter determines the gateway or router used by Ki Pro GO2 on your LAN for TCP/IP networking.

9.4 System Name

This parameter defines a name for Ki Pro GO2 and gives it a unique identifier. This same name is used both when displaying systems via the web interface. The default name is "AJA Ki Pro GO2".

9.5 MAC Address

This parameter is a read-only field showing the MAC address of the Ki Pro GO2's Ethernet adapter.

10.0 Date/Time

This parameter manually sets the calendar date of the internal Ki Pro GO2 clock. The value is defined as month/day/year/hour/minute.

Variable	Using the User Control Knob, enter a calendar date for Ki Pro GO2. Scroll and click the for each element (M/D/Y/HR/M). When finished, the scroll to SAVE and press the knob.
----------	------------------------------------------------------------------------------------------------------------------------------------------------------------------------------

10.1 Time Zone

This parameter manually selects the time zone for the internal Ki Pro GO2 clock.

Table 1. Ki Pro GO2 Time Zones

GRASS VALLEY (default)	AZORES	KUWAIT	BEIJING
LOS ANGELES	LISBON	JEDDA	MANILA
DENVER	LONDON (GMT)	MOSCOW	TAIPEI
MEXICO CITY	MADRID	TEHRAN	SEOUL
DALLAS	PARIS	ABU DHABI	TOKYO
CHICAGO	AMSTERDAM	KABUL	GUAM
DETROIT	ROME	NEW DELHI	SYDNEY
WASH DC	BERLIN	COLOMBO	AUCKLAND
NEW YORK	VIENNA	DHAKA	HONOLULU
MONTREAL	ATHENS	BANGKOK	ANCHORAGE
BOSTON	HELSINKI	HANOI	SEATTLE
CARACAS	CAIRO	SINGAPORE	
BUENOS AIRES	TEL AVIV	JAKARTA	
RIO DE JANEIRO	BEIRUT	HONG KONG	

10.2 Daylight Savings

This parameter can be used to manually set the internal Ki Pro GO2 clock for Daylight Savings Time by adding one hour to the current time.

On (default) Off	Adds one hour to the current time value. No increment is applied.
---------------------	----------------------------------------------------------------------

10.3 FUNC Button

The FUNC button on the Ki Pro GO2 front panel is intended to be used as a quick access shortcut to menu locations. For the initial release only one choice is included, either directly display the Playback Media Source menu, or disable the button.

Disabled Playback Media Source (default)	No action when FUNC button is pressed. Displays the Playback Media Source menu, allowing quick selection of clips on different media.
------------------------------------------------	------------------------------------------------------------------------------------------------------------------------------------------

10.4 Screen Dimmer

This parameter lets you choose when the front panel menu display will be automatically dimmed. Scroll the User Control Knob to enter a time value in minutes. Range is 1 - 60.

10.5 Screen Brightness

This parameter determines the brightness of the alphanumeric LCD display and front panel back-lit buttons.

Variable (default is 6)	Push the User Control Knob to enter the intensity scale. Then scroll to dim or brighten in steps from 1 (dim) to 8 (bright). Push the knob to exit.
----------------------------	-----------------------------------------------------------------------------------------------------------------------------------------------------

11.0 Serial Number

This parameter displays this Ki Pro GO2's unique serial number (Read-only).

11.1 Software Version

This parameter displays this Ki Pro GO2's software version level (Read-only).

12.0 Recall Preset

This parameter recalls the Ki Pro GO2 settings of a previously saved preset. Push the User Control Knob to enter the Preset Recall scale and scroll to choose the Preset (1 to 20). Press the knob to select and confirm action by scrolling and clicking on OK or Cancel.

12.1 Store Preset

This parameter saves a preset configuration to the selected storage register. Use the User Control Knob to scroll to the number of the Preset register. To store, press the knob, and then select and press OK. The message "Complete" is displayed after a successful store.

99.0 Factory Reset

Selecting this parameter and then pressing the User Control Knob brings up the Confirm Action screen. Press on OK to recall Ki Pro GO2' factory default settings.

CAUTION: *Selecting this parameter and recalling factory defaults overwrites the current settings*

Recalling factory defaults does not affect these settings:

IP Address	MAC Address	Recall Preset
Subnet Mask	Date/Time	Store Preset
Static Gateway	Serial Number	
System Name	SW Version	

MEDIA Menus

The MEDIA menu parameters affect media storage and the type of encoding to be used. Menus are also available for naming and numbering clips.

MEDIA Menu Parameters

About Clip Names

Ki Pro GO2 automatically creates a unique file name for each recorded clip. The file name can have the following components, separated by underscore characters:

<Clip Name>_<Ch #>_<Clip #>_<Segment #>_<Backup>(Overwrite).mp4

<Clip Name> is the first file name component. Default for this is "Clip". This component of the file name can be customized for each Ki Pro GO2 recording channel using that channel's Clip Name parameter.

<Ch #> identifies the Ki Pro GO2 recording channel, as either ch1, ch2, ch3, or ch4.

<Clip #> is a four digit clip number included in the file names of all clips recorded at the same time by any Ki Pro GO2 recording channel. This number increments each time a recording completes. Default starting value is 0001, it increments to 9999 and then rolls back to 0001. You can define a new starting clip number using the Ki Pro GO2's Clip Number parameter.

<Segment #> identifies each segment of a continuous recording. Each time a Record Minutes (max) recording duration is reached, Ki Pro GO2 begins recording a new segment and increments the segment number of that new clip's file name. Starting value is 0001 for the first recorded segment, it increments with each new segment up to 9999, and then rolls back to 0001.

<Backup> is an optional component only used to identify backup recordings. Backup recordings will have "_bak" appended to their file names.

(Overwrite) is another optional identifier used to prevent accidentally overwriting clips with the same file name. Ascending (1), (2), etc. numbers in parentheses are added to the file names of clips that would otherwise have overwritten previously recorded clips of the same name.

Table 2. Clip File Naming Examples

Clip_ch1_0001_0001.mp4	Default Clip Name, Recording Channel 1, first recorded clip, first recorded segment of that clip, not a backup, and not a multi-segment recording.
StageLeft_ch1_0025_0001.mp4 StageRight_ch2_0025_0001.mp4 CenterHall_ch3_0025_0001.mp4 BackStage_ch4_0025_0001.mp4	Four custom named clips recorded simultaneously, Clip Number was set to 25.
StageLeft_ch1_0026_0001.mp4 StageRight_ch2_0026_0001.mp4 CenterHall_ch3_0026_0001.mp4 BackStage_ch4_0026_0001.mp4	Subsequent recordings using the same setup above, incrementing the clip number for each new clip.
StageLeft_ch1_0027_0001.mp4 StageLeft_ch1_0027_0001_bak.mp4	Primary and backup recordings of the same material.
StageRight_ch2_0028_0001.mp4 StageRight_ch2_0028_0002.mp4 StageRight_ch2_0028_0003.mp4	Three clips from a segmented recording.
CenterHall_ch3_0029_0001.mp4 CenterHall_ch3_0029_0001(1).mp4 CenterHall_ch3_0029_0001(2).mp4	File names of clips recorded if that clip name already exists.

20.0 Video Encoder

Choices are:

- H.264
- H.265 (default)

21.0 Channel 1 Clip Name

This parameter determines the first component of the clip name generated by Ki Pro GO2's recording Channel 1. The default name is "Clip". You can enter up to 20 ASCII characters, except those in [Table 3](#) are prohibited:

Table 3. Prohibited Clip Name Characters

<	less than	\	backslash	_	underscore
>	greater than		vertical bar or pipe	%	percent
:	colon	?	question mark	(opening parenthesis
"	double quote	*	asterisk)	closing parenthesis
/	forward slash	.	period	+	plus sign

21.1 Channel 1 Encode Quality

This parameter sets that channel's recorded clip encode quality. The resulting bitrates are adjusted to match the video format and frame rate for each quality setting.

Low Med-Low Medium (default) Med-High High	Selects the indicated encode quality level.
--------------------------------------------------------	---------------------------------------------

NOTE: For more detailed information about bitrates, please see: "[Ki Pro GO2 Encoding Parameters](#)" on page 59.

21.2 Channel 1 Encode Bit Depth

Sets the color depth sampling. Select from:

- 8-bit (default)
- 10-bit

NOTE: For better file interoperability with 3rd party applications, it is recommended to keep this setting at 8-bit.

21.3 Channel 1 Encode Sampling

Sets the color encoding. Select from:

- 4:2:0 (default)
- 4:2:2

NOTE: For better file interoperability with 3rd party applications, it is recommended to keep this setting at 4:2:0.

21.4 Channel 1 Encode B-frames

NOTE: Beginning with v4.0 firmware, Ki Pro GO2 can encode .mp4 with I, P and B frames.

Defines the B frame cadence. Select from:

- 0 (default, no B frames),
- 1 frame
- 2 frames
- 3 frames
- 4 frames

22.0 Channel 1 Primary Rec Dest

Selects which USB port will be used for this channel's primary recorded clips.

Select from:

USB Port 1 USB Port 2 USB Port 3 USB Port 4 USB Port 5 SMB	By default, each Ki Pro GO2 recording channel uses the USB port number matching that channel's number. This can be changed by selecting a different USB Port for that channel. Selects an SMB SHARE (NAS) for recording.
---------------------------------------------------------------------------	---------------------------------------------------------------------------------------------------------------------------------------------------------------------------------------------------------------------------------

22.1 Channel 1 Backup Rec Dest

Enables the recording of backup clips encoded by this channel. The backup clip's content will be identical to the primary clip, and "_bak" will be appended to the backup clip's file name. Select from:

None (default) USB Port 1 USB Port 2 USB Port 3 USB Port 4 USB Port 5 SMB	No backup recording will be performed for this channel. Choose the desired USB Port 1-5 for backup recording for that channel. Selects an SMB SHARE (NAS) for backup recording.
---------------------------------------------------------------------------------------------	----------------------------------------------------------------------------------------------------------------------------------------------------------------------------------------

23.0 - 28.1 Channel 2, 3, and 4 Encode Settings

Parameters for Clip Name, Encode Quality, and Backup Rec Dest are available for the other three Ki Pro GO2 recording channels.

- 23.0 - 24.1 = Channel 2 menu numbers
- 25.0 - 26.1 = Channel 3 menu numbers
- 27.0 - 28.1 = Channel 4 menu numbers

29.0 Record Minutes (max)

This parameter specifies the maximum record length of clips. The range is 5 minutes to 240 minutes (4 hrs).

5 to 240 (default = 240)	Press Control Knob and scroll up or down to change the Record Minutes (max) value.
-----------------------------	------------------------------------------------------------------------------------

If the max time is reached, Ki Pro GO2 automatically completes recording that clip, immediately creates a new segmented clip, and continues recording new segmented clips indefinitely. Each new recorded clip will have its file name segment number incremented by one.

NOTE: The FAT32 file system has a 4GB file size limit. If a recorded clip exceeds that size, Ki Pro GO2 will automatically create a new segment, same as when the Record Minutes (max) limit is reached.

29.1 Record Type

This parameter defines the encoding file format.

mp4 (default) mov	Record media as .mp4. Record media as .mov.
----------------------	------------------------------------------------

31.0 Clip Number

This parameter determines the clip number, from 1 to 9999, that follows the Clip Name, and is associated with all clips generated while using this setting. This number is incremented automatically when new clips are recorded, and resets to 1 after reaching 9999.

1 to 9999 (default = 1)	Press Control Knob and scroll up or down to change the Clip Number value from 1 to 9999.
----------------------------	------------------------------------------------------------------------------------------

32.0 - 32.4 USB Port 1-5 Media Path

Opens a text editing window that lets you create a directory structure on the media into which clips will be saved. Up to 15 characters can be entered, with the period or dot (.) character prohibited.

32.5 SMB Server and Share

NOTE: *If an SMB Server is not mounted, this and some of the following related menus will not display information.*

If using an SMB Server for recording or playback, the Ki Pro GO2 must know the network path to the Shared folder on the SMB Server, and the path within that Shared Folder to a sub-folder, called the Record Folder, that will receive or playback the recorded files. You use the SMB Server and Share parameter to set the path to the SMB Shared Folder, and then use the SMB Record Path parameter to define the continued path within the Shared Folder to the Record Folder. See "[SMB Support](#)" on page 7 for background information.

In the Ki Pro GO2's SMB Server and Share menu, enter the path to the Shared Folder, using the SMB Server Name or its IP address and share name, separated by "/" (forward slashes).

in situations where the Ki Pro GO2 is on a network with a DNS server, enter the Server Name using the format below with double leading forward slashes:

//myserver/volume/shared folder

For all other configurations, enter an IP address, using the following format without leading forward slashes:

10.0.0.99/volume/shared folder.

NOTE: *When entering the SMB Server and Share information, be sure that the shared folder already exists on the volume and that the share offers both read and write privileges. If this is not the situation, Ki Pro GO2 will fail to mount the SMB share and report an error.*

32.6 SMB Network Record Path

Having entered the path to the shared folder in the "SMB Server and Share" field, you can now define a continued path to the Record Folder within the Shared Folder. In many use cases, this path will simply be the name of a sub-folder in the Shared Folder.

You can define a path of folders and subfolders, separated by "/" (forward slashes) to the Record Folder. Up to 15 characters can be entered, with the period or dot (.) character prohibited.

SMB and Record Paths

If the Network Record folder entered in the "SMB Network Record Path" field is not present in the shared folder, Ki Pro GO2 will create it the next time Ki Pro GO2 records to that location.

If the Network Record directory field is left blank, Ki Pro GO2 will create a folder named AJA the next time Ki Pro GO2 records to that location, and will store media into that default folder.

32.7 SMB Dialect

Use the SMB Dialect control to select a specific version of the Server Message Block (SMB) protocol to use with a remote SMB share. Start with Auto unless you experience long connection delays (two minutes or more).

Auto (default) is recommended for most applications. When Auto is selected, Ki Pro GO2 will start with the most secure setting (SMB 3.1.1), and work its way sequentially through the list until a compatible setting is found. SMB 2.0 is the lowest version the Auto setting will negotiate to. Generally, the higher the number, the higher the security.

If using an SMB Server for recording, select the SMB dialect. Choose from:

- Auto, SMB 3.1.1, 3.0.2, 3.0, 2.1, or 2.0.

32.8 Domain

If using an SMB Server for recording, enter the Windows domain, or clear the field for none. If an SMB Server is not mounted this menu will not display information.

32.9 Domain Username

If using an SMB Server for recording, enter the user name, or clear the field for none. If an SMB Server is not mounted, this menu will not display information.

32.10 Domain Password

If using an SMB Server for recording, enter the password, or clear the field for none. This field will never display information, for security purposes. You will only see the password as you enter it with the knob.

34.0 Playback Media Source

Selects which USB media will be used for clip playback. Only one clip can be played back at a time. Select from:

- USB Port 1 (default), USB Port 2, USB Port 3, USB Port 4, USB Port 5, or SMB.

IMPORTANT: If an SMB share is too slow for a particular playback source, or if the network is too congested during playback, the AV sync for that source can begin to slip.

34.1 Playback Type

This parameter determines behavior during playback. Ki Pro GO2 will play all clips regardless of format or frame rate.

All (default) Clip	Plays the current clip and then continues playing the next clip on that Ki Pro GO2 media. Plays one clip and then stops playback.
-----------------------	--------------------------------------------------------------------------------------------------------------------------------------

NOTE: If all clips are the same format and frame rate, they should play out smoothly one after another. If the formats or frame rates are different, the video may reset between clips.

34.2 Loop Playback

This parameter turns looped playback on and off.

On (default) Off	Play clip(s) and then loop back and repeat playback. Play clip(s) and then stop playback when complete.
---------------------	------------------------------------------------------------------------------------------------------------

About Formatting USB Media

Ki Pro GO2 requires the use of formatted media. Ki Pro GO2 the following file systems:

- exFAT (default format)
- FAT32
- FAT16

Newly purchased USB media is usually pre-formatted by the manufacturer before shipment.

Ki Pro GO2 can format USB media, but only as exFAT. If formatted media of a different type is reformatted using Ki Pro GO2, the existing formatting will be lost along with any data, and will be formatted as exFAT.

NOTE: AJA recommends using and/or formatting to exFAT for best results due to file size constraints of FAT32 and FAT16.

35.1 - 35.5 Format USB Port 1-5 Media

Formats the media currently located in the selected USB port.

1. Press the front panel knob in to display a Confirm prompt.
2. Turn the knob to select OK.
3. Press the front panel knob a second time to initiate the formatting.

Prompts will be displayed indicating the formatting progress.

35.6 Format All USB Media

Formats all media currently installed into the Ki Pro GO2's USB ports, with the procedure above.

Chapter 5 – Browser Remote Control

Overview

An optimized web server running on Ki Pro GO2 allows you to remotely play and record clips, and monitor and adjust parameter settings via a web browser client running on a connected computer. Preferred web browsers for Ki Pro GO2 are:

Mac OS

- Chrome
- Safari
- Firefox

Windows OS

- Chrome
- Firefox

NOTE: Other web browsers may work, but AJA cannot guarantee consistent operation for all web browsers or web browser versions. If you do experience an unexpected behavior when using a particular web browser or web browser version to interact with Ki Pro GO2, consider using an alternate web browser and report any issues experienced to AJA Technical Support.

Ki Pro GO2 Web UI Description

Figure 20. Ki Pro GO2 Web UI Status Screen Example

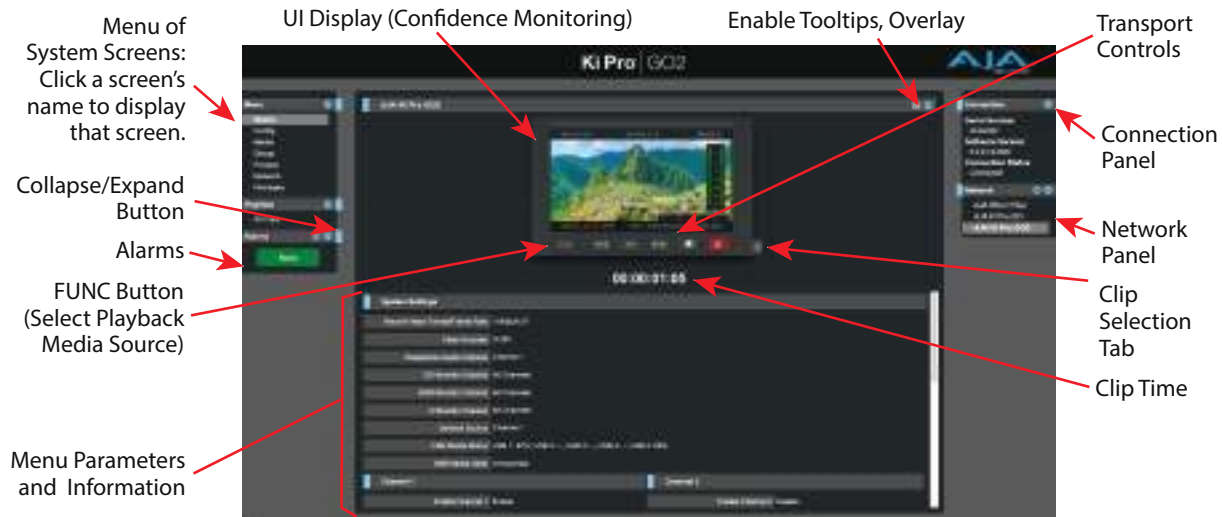

All Ki Pro GO2 web UI screens have certain areas in common.

- At the top of each screen an emulation of the Ki Pro GO2 front panel can be displayed or hidden by clicking on the blue up/down arrow on the top line.
- When this top pane is open, transport controls, including a red RECORD button, are shown that are linked to the hardware transport buttons located on the Ki Pro GO2's front panel. A timecode display reports the record or playback time for the current clip.

- Next to the up/down arrow button on the top line is a dropdown menu button for enabling Monitor Tooltips (hover cursor over a transport button function to show its function), and showing or hiding Web UI Overlays.
- Clicking on the **FUNC** button presents a list of USB media that can be selected for recording or playback (*Figure 21*).

Figure 21. Web UI Port and Clip Selection



- Clicking on the > tab on the right displays a **Clips** icon. Hovering your cursor over this icon and turning the mouse's scroll wheel allows selection of a different clip for playback (*Figure 21*). If a clip is playing at the time, that playback stops (pauses). Hitting Play after scrolling the clip list will cause the selected clip to play.
- On the left of each screen is a Menu panel listing the available Ki Pro GO2 web UI screens. Click any of these items to jump to that screen.
- Below the Menu panel is a Playlists tab (see "*Playlists Screen*" on page 54).
- The Alarms pane below reports Ki Pro GO2 alarm conditions.
- Below the Playlists tab is an Alarms tab. Beginning with Ki Pro GO2 version 4.0, you can clear inactive, non-current recording-related alarm notifications from being displayed. Active alarms notifications are always shown. Clicking on the Alarms gear icon or on an alarm message opens a window with a Clear Alarms button at the bottom. Clicking on that button clears inactive recording alarms from being displayed.

Figure 22. Ki Pro GO2 Web UI Config Screen, Clear Inactive Alarms



- On the right side of each screen is a Connection panel. This area shows the connection status and Ki Pro GO2's serial number and software version. This latter information is useful if you call AJA for technical support.
- Below the Connection panel, the Network panel shows AJA devices on the network, and allows you to switch your connection to a different device by clicking on that device's name.
- In the middle of each screen are the menu parameter choices and information pertaining to that screen.

The blue circled arrow icons can be clicked to toggle a pane open or closed.

Standard scroll bars on the right and bottom allow screen navigation, and are hidden when the entire screen's height or width is displayed.

Hovering your mouse cursor over a parameter name brings up a tooltip describing that parameter.

Right clicking on a parameter name lets you reset that value to the factory default.

Ki Pro GO2 Web UI Screens

Ki Pro GO2 Web UI screens closely mirror the parameter menus displayed on its front panel, with some variations.

Status Screen

Figure 23. Status Screen, with UI Display Pane Open



The Status screen displays the current configuration state of the Ki Pro GO2. When an SMB volume is mounted, its status is displayed along with additional SMB parameter information. When Unmounted, these parameters are hidden on this screen.

The information displayed is the same Chnl/Input and File/Encode status information as shown on that Ki Pro GO2's front panel Status menu, except alarms are not displayed.

On the Ki Pro GO2 Web UI you can see alarm messages at any time from any screen by opening the Alarms pane on the left.

Figure 24. Alarms Pane



Media Screen

Figure 27. Ki Pro GO2 Media Screen (scrolled up)



Figure 28. Ki Pro GO2 Media Screen (scrolled down)



Figure 29. Ki Pro GO2 Media Screen (scrolled further down)



SMB Parameter Editing

To clear an SMB parameter, right click on the blue text (the name of the parameter), and select "reset to factory".

Group Screen

At-a-glance you can see all of the Ki Pro systems that are present on the same local LAN in the Network drop-down pane on the right side of the web UI screen.

Figure 30. Group Recording Screen



Click a system name to switch the browser to that particular Ki Pro system.

NOTE: You must have a properly configured default gateway to see the AJA devices. If the Default Gateway is not configured properly, other AJA devices will not be listed.

Multiple Ki Pro units can be used in unison to produce recordings via the Group Control feature. This feature is only available via the web UI when the units have IP addresses configured under a common network and subnet mask and are connected via their LAN connections to an Ethernet switch or hub to a host computer. AJA recommends that all Ki Pro units in a Group use matching firmware versions.

AJA devices supporting Group recording, including automatically matched clip names, are:

- Ki Pro Ultra Plus (v5.1 or later, and uses Gang, and Master terminology)
- Ki Pro Ultra (uses Gang, and Master terminology)
- Ki Pro Ultra 12G

AJA devices supporting Group recording, except for matched clip names, include:

- Ki Pro GO2 , HELO Plus, and Ki Pro GO (v2.0 or later)

Group recording, including automatically matched clip names, operates by having a Leader Ki Pro unit send three items to the Follower Ki Pros within a Group; a record start command, a record stop command, and also, if the Leader is a Ki Pro Ultra, Ki Pro Ultra Plus or Ki Pro Ultra 12G, clip name data. Ki Pro Ultra Plus and Ki Pro Ultra 12G Follower units can accept all three commands, permitting automatic clip name matching. Ki Pro GO2 units, however, do not support clip name data sharing. If a Ki Pro GO2 is a Follower, it only accepts the record start and stop commands, not the clip name data. If a Ki Pro GO2 is the Leader of a Group, it can only send record start and stop commands to the Follower units, so in this case automatic matched clip naming is not possible.

NOTE: The clip names of Ki Pro GO2 Leader and Follower in a Group can be matched by manually entering clip names and clip numbers to ensure the naming convention for all the Ki Pro GO2 units in the Group are the same.

Group Recording Example

NOTE: To demonstrate full Group recording operation, this example will not include a Ki Pro GO2 in the Group, because that model does not fully support the clip naming feature. This example works with Ki Pro Ultra Plus and Ki Pro Ultra 12G models.

You have a Ki Pro “Leader” and a Ki Pro “Follower” both attached on a network where their static IP addresses are 192.168.0.2 and 192.168.0.3, both with a subnet mask value of 255.255.255.0. They are connected to a host computer with IP address 192.168.0.1 and subnet mask 255.255.255.0. The host computer uses a web browser to access the “Leader” Ki Pro by entering 192.168.0.2 in the URL field of the browser. The Ki Pro “Leader” unit web UI should appear. Locate the Group Controls area in the user interface.

Parameters for each available Ki Pro will appear in the Group Controls area. These include:

- System – displays units that may be added to a Group
- Record Format – type of video format/frame rate each system is configured to record
- Free Storage – at-a-glance view of the available capacity of the media in each unit
- Group – units can be added or removed from the Group
- Leader – allows the promotion of a Ki Pro unit to the controlling role
- Settings – allows for the configuration of clip names on the Leader and Follower Ki Pro units (except Ki Pro GO2 models).

To add a Ki Pro to a Group, simply select the check box for the unit in the Group column. As a shortcut, if all available Ki Pro units are desired for a Group, select the All item below Group. If you want to clear units from a Group, deselect them or use the Clear option.

There can be only one Leader in a Group; typically, the IP address for the Ki Pro unit you entered and are viewing the web UI on is the one which should be promoted to the controlling role. If the unit with the IP address that is currently being viewed via the web UI is selected, a red capitalized LEADER text will appear on the web page above the columns.

The Settings area is where the Ki Pro clip name for each unit is decided. By default, Ki Pro is configured to use the standard clip naming conventions, not the custom clip naming conventions. The first user selection is Use Custom Clip Name; if you want to use the standard clip naming convention, leave this set to OFF. If you want to create a custom clip name, mouse click on the OFF to reveal a pulldown, select ON, and then click OK. You may now enter a custom name to be used for recordings. If OFF was selected, the next parameter would be Clip Name, again, clicking on the SC or Clip presented brings up the pulldown and the OK box. Clip Number must be entered manually with a valid value of 1 through 999 and then the enter/return key must be hit. If the enter/return key is not entered after the selection, the value will revert to whatever was previously shown.

Clicking on the value next to Clip Append and Alpha Append both bring up a pulldown and an OK button. Take operates like the Clip Number, where a valid value of 1 to 999 can be entered and the enter/return key needs to be hit for confirmation of the value.

For Follower Ki Pro Ultra Plus and Ki Pro Ultra 12G models, the Settings column provides a selection of either Use: Leader Name or Follower Name. If the Leader device is also one of these models, full clip name matching is available. Clicking on the default value of Leader Name pulls up a pulldown selection of Leader Name or Follower Name with an OK confirmation button. If the desire is to have clips named the same across all Ki Pro units' recordings, then select Use: Leader Name. If the desire is to have clips named independently on Ki Pro units, then select Follower Name. Selecting Follower Name means that the recording will take it's name from the individual Ki Pro's parameters and not accept the value pushed to the Follower by the Leader Ki Pro.

NOTE: Ki Pro can initiate recordings among units quickly, but not all units will begin or end recordings precisely at the same time or the same frame. This is not an issue if matching timecode via LTC or RP188.

Presets Screen

Figure 31. Ki Pro GO2 Presets Screen



The Presets screen allows you to save Preset Configurations into 20 separate memory registers and recall a preset whenever needed.

This screen also includes Export and Import functions that allow exporting one or all presets to your computer as files and importing exported preset files from your computer. A displayed message indicates successful or failed saves, recalls, exports, and imports.

NOTE: Exported Ki Pro GO presets can be imported and used by a Ki Pro GO2. but not vice-versa.

Save Buttons

The Save buttons let you save the current configuration into the preset register with the associated name and number. A preset is a set of system parameters as they were set at the time the preset was stored. Only editable parameters are saved in the presets. Non- editable parameters are not saved.

To change a preset name, click in the name's text field and type a new name. Then press Enter.

When you recall a Preset Configuration, the recalled preset immediately replaces the system's existing configuration. All previous settings are lost unless you have previously stored them in another preset configuration or an exported file.

Import Buttons

The Import buttons let you browse for and import a preset file on your computer into the preset register associated with the selected button. A dialog box warns you that the operation will overwrite the current preset contents with the contents stored in the file.

Import Presets 1-20 lets you browse for and import a previously exported "all.presets" file from your computer. A dialog box warns you that the operation will overwrite all 20 current preset contents with the contents stored in the file.

Export Buttons

The Export buttons save the associated preset contents to a file on your computer. The file gets exported to the default download location specified in your browser options. The file name is the same as the preset name with the suffix .presets. If you export multiple files for the same preset, a number gets appended to ensure a unique file name. The file size is small, usually less than 10 kilobytes.

Export Presets 1-20 lets you save the contents of all presets to a file on your computer. The file gets exported to the default download location specified in your browser options with the name "all.presets". If you export multiple files, a number gets appended to ensure a unique file name.

Recall Factory Preset

Recall Factory Preset recalls all editable video and audio parameters to their factory default settings. Individual presets, user preferences, and Network settings, such as the IP Address, are not affected.

Network Panel

Ki Pro GO2's Web UI provides access to the Network Panel in two ways, either by clicking on **Network** in the Menu list on the right, or by clicking on the blue gear icon in the Network pane on the right. The information displayed depends on the current network configuration.

Figure 32. Network Panel, DHCP



The very top of your computer's web browser screen should always report the current IP address assigned to your Ki Pro GO2 by the DHCP server.

Figure 33. Network Panel, Static IP



NOTE: LANs may be divided into zones, and devices on a LAN may have dynamically assigned (DHCP) IP addresses, or fixed (static) IP addresses. Before connecting Ki Pro GO2 to the LAN, talk to your network administrators to find out how they want it connected (DHCP or Static IP).

To configure a static IP address:

1. Click on the IP Address Type drop-down menu, and select **Static**.
2. Use standard text editing methods to change the IP address data, and then click **Apply**. You will be prompted to confirm the change.

Figure 34. Network Panel, IP Address Change Confirmation



3. Click **Confirm**.

Ki Pro GO2 will reset its network configuration and the Web UI will reconnect to it, if a valid network configuration was entered.

Firmware Screen

The Firmware screen allows you to update your Ki Pro GO2 to a newer version of firmware as issued by AJA. Firmware updates often contain new features, improvements, and bulletins that may be very useful to you.

Figure 35. Ki Pro GO2 Firmware Screen



Firmware Update Procedure

1. Download the Latest Ki Pro GO2 firmware. Current and past releases of Ki Pro GO2 firmware are available from AJA's website:

<https://www.aja.com/products/ki-pro-go#support>

If your Ki Pro GO2 has access to the Internet, you can also directly reach this location by clicking the **Ki Pro GO2 Support Page** button on the Ki Pro GO2's Firmware screen.

2. Select the Ki Pro GO2 firmware file for download from the website.

The firmware image to install on your Ki Pro GO2 has an ".ajas" extension. Depending on your PC or Mac operating system settings, the extension may not be visible to you in a file directory.

3. Go to the Ki Pro GO2 Firmware screen.
4. Click **Choose File** and navigate to the downloaded Ki Pro GO2 firmware file.
5. When a valid Ki Pro GO2 firmware file has been selected, click **Upload**. The file is tested for validity. Incomplete, corrupted, or non-Ki Pro GO2 firmware files will be rejected.
6. Agree to the steps and confirmation prompts as they are presented. Wait for the procedure to complete (it will take only a few minutes). When done, Ki Pro GO2 will prompt you to restart your machine.
7. Restart your Ki Pro GO2 by clicking on **Close**, or by power cycling the Ki Pro GO2.

CAUTION: AJA strongly recommends performing a factory reset after updating Ki Pro GO2 firmware.

If there is a power outage or glitch during the firmware download, Ki Pro GO2 will boot the previously installed software version and the upgrade process can then be re-started.

Safeboot

Ki Pro GO2 has a safety feature where an internal "safeboot" copy of earlier software is retained in the event the update process fails or its software becomes corrupted. You can initiate a safeboot of the Ki Pro GO2 by holding in the front panel **STATUS** button while powering up, which launches the previously installed Ki Pro GO2 software version.

Playlists Screen

Figure 36. Ki Pro GO2 Playlists Screen



The Playlists screen lists all the clips available on the currently selected media. The currently selected clip is highlighted blue, and a mini-player with four buttons is shown for that clip. Clip record and play operations must stop before a different clip can be selected on the list.

The clip list tracks the currently configured Playback Media Source, which can be set from the Ki Pro GO2's front panel Media menu. The Playback Media Source can also be changed from this Web UI screen. You must stop clip playback or recording before you can select a different Playback Media Source.

To select different media from the Web UI, click on the USB Port number on the top of the pane and select the new source from the drop-down list. This changes the Playback Media Source parameter to match.

Figure 37. Ki Pro GO2 Playlists Screen Media Selection



The following information is displayed for each clip:

- Clip Name
- Video Format
- Starting Time Code
- Time Duration of Clip
- Date and Time of Recording
- Encode Type (H.265 or H.264)
- Number of Audio Channels

Quick Cueing

You can cue up a clip quickly by simply double-clicking the clip in the list. That clip will be highlighted in blue in the list and its first frame of video will appear on the output of the Ki Pro GO2.

You can also quickly scan material by setting the Media Playback Type to **All** so that as you highlight clips for review, they will continue playing out of the Ki Pro GO2 outputs.

Clip Playback

To playback a cued clip using the Web UI, you can simply click on the **PLAY** transport button at the top of the screen.

You can also use the “mini-player” from within the playlist, which has Transport Control buttons that apply to that clip.

If a clip is currently active in playback, double-clicking on a different clip in the playlist initiates the playback of that new clip.

Clip Download

Ki Pro GO2 supports downloading clips to your local computer, by selecting one or more clips and clicking on the Download button.

Downloads are only allowed in IDLE to avoid the risk of any record/playback interference. If a Record or playback is initiated, the download will abort.

Uploads are not supported.

Playlist Refresh

The Refresh button on the upper right refreshes the clip information shown on the Playlists screen with the current directory information for a mounted SMB share. This button is not active when using USB media.

Ki Pro GO2 reads the SMB directory when it is mounted, and when a new clip begins to be added or deleted, and displays this information on the Playlists screen. This information will be accurate most of the time. However, if, for example, a new clip is in the process of being added when the SMB directory is read, the displayed duration for that clip on the Playlists screen may not be correct. Press this button to refresh the Ki Pro GO2's clip information displayed on the Playlists screen with the current SMB directory information.

Appendix A – Specifications

Ki Pro GO2 Tech Specs

Video Formats

- (HD) 1080p 23.98, 24, 25, 29.97, 30, 50, 59.94, 60
- (HD) 1080i 50, 59.94, 60*
- (HD) 1080PsF 23.98, 24, 25, 29.97, 30**,**
- (HD) 720p 50, 59.94, 60
- (SD) 525i 59.94*
- (SD) 625i 50*

* Recording will be converted to progressive

** PsF input support only

Note: Multi-channel recording requires the same frame rate and resolution for all input sources.

Video Codec Support

- Supports H.265/HEVC, up to 15 Mbps recorded output
- Supports H.264/MPEG-4, up to 25 Mbps recorded output

Audio Codec Support

- 4x audio compression codecs
- 2-channel audio support for each
- Up to 320 kbps
- MPEG-4 AAC-LC

Codec Container

- .MP4

Removable Storage

- 5x USB 3.2 Gen 1 (5 Gbps) ports
- All ports are also compatible with the following standards:
 - USB 2.0 (480 Mbps)
 - USB 3.0 (5 Gbps)*
 - USB 3.2 Gen 1 (5 Gbps)*
- 5V 1A max current per port

*Also referred to as SuperSpeed USB

Removable Storage File System Support

- FAT file systems
 - FAT16
 - FAT32
 - exFAT
- In-system formatting support for exFAT only

Network Storage

- SMB support via GigE port*
 - Only 1x network storage device can be used at any one time
 - Connection via IP address or DNS entry
 - Requires (externally defined) domain name, domain user name, user password
 - Customer must ensure sufficient bandwidth is available for recording*

*GigE network connectivity to storage is required, with 150 Mbps of bandwidth permanently available for media storage

SMB Protocols Supported

- SMB 3.1.1
- SMB 3.0.2
- SMB 3.02
- SMB 2.1
- SMB 2.0

Video Input

- 4x 3G-SDI BNC, SMPTE-259/292/424, 4:2:2 10-bit
- 4x HDMI standard Type A connector
- HDMI v1.4a
 - 4:4:4 RGB 8, 10-bit (deep color)
 - 4:2:2 YCbCr 8, 10, or 12-bit
 - 4:2:0 YCbCr 8-bit

Video Output

- 5x 3G-SDI BNC, SMPTE-259/292/424, 4:2:2 10-bit
- 1x HDMI standard Type A connector
- HDMI v1.4a
 - 4:4:4 RGB 8, 10-bit (deep color)
 - 4:2:2 YCbCr 8/10/12-bit
 - 4:2:0 YCbCr 8-bit

Audio Input

- 4x SDI audio
 - 2-channel, 24-bit embedded audio
 - 48 kHz sample rate, synchronous
 - Sample rate converted to 48 kHz internally
- 4x HDMI audio
 - 2-channel, 24-bit HDMI embedded audio
 - 32 kHz, 44.1 kHz, 48 kHz sample rates, synchronous
 - Sample rate converted to 48 kHz internally
- 2x XLR input
 - Line/Mic/+48V Phantom Power Mic Levels supported (selectable by rear switch)
 - +24 dB full scale digital
 - +/- 0.3 dBFS 20 Hz to 20 kHz response
 - THD+N <= -90 dB

Audio Output

- 5x SDI embedded
 - 2-channel, 24-bit embedded audio
 - 48 kHz sample rate, synchronous
- 1x HDMI embedded
 - 2-channel, 24-bit embedded audio
 - 48 kHz sample rate, synchronous
- Stereo unbalanced headphone jack (1x 3.5mm jack) with volume control
- 2-channel unbalanced 2x RCA connectors

Video Conversion

- Deinterlacing for recording
- Interlacing for playback (optional)
- PsF to progressive

Timecode

- SDI RP 188/SMPTE 12M via SDI BNC
- LTC input (via Analog Audio XLR in R)
- TC Super Out

Reference Input

- External, 2x BNC
- Looping, nonterminating
- Input reference formats:
 - (HD) Tri-level sync
 - 720p 59.94
 - 720p 50
 - 1080i 59.94
 - 1080i 50
 - 1080p 23.98
 - 1080PsF 23.98
 - 1080p 24
 - 1080PsF 24
 - 1080p 25
 - 1080PsF 25
 - (SD) Analog composite
 - 525i 59.94
 - 625i 50

Network Interface

- 1x LAN connector (RJ-45 connector, 10/100/1000)
- Embedded web server for remote control
- Configuration and Transport Control via WEB Interface
- Clip download via Web Interface
- Remote control via REST

User Interface

- Rotary Selector knob
- Dedicated backlit transport controls and menu buttons
- Large 1280x720 TFT LCD display with Video Monitor and Menu/Status Overlays

Size (w x d x h)

- 8.64" x 10.59" x 3.31" (219.46 x 268.90 x 84.08 mm)

Weight

- 5.1 lbs (2.3 kg)

Power

- External power supply required
 - Enclosure: Dual, redundant, 12-18VDC regulated, 4-pin XLR, 55W typical, 90W max.
 - AC adapter, included: 100-240VAC, 50/60 Hz, universal input, 12V, 7A output
 - Optional redundant AC adapter sold separately, KPU-PWR-SUPPLY

Environment

- Safe Operating Temperature: 0 to 40 C (32 to 104 F)
- Safe Storage Temperature (Power OFF): -40 to 60 C (-40 to 140 F)
- Operating Relative Humidity: 10-90% non-condensing
- Operating Altitude: <3,000 meters (<10,000 feet)

Ki Pro GO2 Encoding Parameters

Entropy Encoding

Ki Pro GO2 uses the CABAC (Context Based Adaptive Binary Arithmetic Coding) algorithm for entropy encoding.

I/P Frame Structure (GOP Length)

Ki Pro GO2 encodes an I-frame once per second, which makes the GOP (Group-Of-Pictures) size equal to the frame rate of the video. For example, with 1080p50 video the GOP size will be 50, or 1 second.

Ki Pro GO2 can encode files with 0, 1, 2, 3 or 4 B-frame cadence (v4.0 and later).

Bit Depth and Sampling

Ki Pro GO2 supports both 8-bit and 10-bit encoding and decoding of video. Ki Pro GO2 also supports 4:2:0 as well as 4:2:2 encoding and decoding of video.

Many 3rd party applications only support 8-bit and 4:2:0, so for maximum compatibility it is recommended to keep the encoding selections at 8-bit and 4:2:0.

H.264 / H.265 and Bitrates

Ki Pro GO2 can encode using H.264 or H.265 profiles. The bitrate is variable and frame rate dependent.

Table 4. Ki Pro GO2 H.264 Encoding Bitrate Table

Video Format	Target Bit Rates (Mbits/sec)					Encoding Variation by Input Format
	Low	Med-Low	Medium	Med-High	High	
1080p59.94\60	5.0	10.0	15.0	20.0	25.0	
1080p50	4.2	8.3	12.5	16.7	20.8	
1080p29.97\30	2.5	5.0	7.5	10.0	12.5	
1080p25	2.1	4.2	6.3	8.3	10.4	
1080p23.98\24	2.0	4.0	6.0	8.0	10.0	
1080PsF30	2.5	5.0	7.5	10.0	12.5	1080PsF30 > 1080p30
1080PsF29.97	2.5	5.0	7.5	10.0	12.5	1080PsF29.97 > 1080p29.97
1080PsF25	2.1	4.2	6.3	8.3	10.4	1080PsF25 > 1080p25
1080PsF24	2.0	4.0	6.0	8.0	10.0	1080PsF24 > 1080p24
1080PsF23.98	2.0	4.0	6.0	8.0	10.0	1080PsF23.98 > 1080p23.98
1080i60	5.0	10.0	15.0	20.0	25.0	1080i60 > 1080p60
1080i59.94	5.0	10.0	15.0	20.0	25.0	1080i59.94 > 1080p59.94
1080i50	4.2	8.3	12.5	16.7	20.8	1080i50 > 1080p50
720p59.94\60	2.2	4.4	6.7	8.9	11.1	
720p50	1.9	3.7	5.6	7.4	9.3	
625i50	0.8	1.7	2.5	3.3	4.2	625i50 > 625p50
525i59.94	0.8	1.7	2.5	3.3	4.2	525i59.94 > 525p59.94

Table 5. Ki Pro GO2 H.265 Encoding Bitrate Table

Video Format	Target Bit Rates (Mbits/second)				
	Low	Med-Low	Medium	Med-High	High
1080p59.94\60	3.0	6.0	9.0	12.0	15.0
1080p50	2.5	4.5	7.5	10.0	12.5
1080p29.97\30	1.5	3.0	4.5	6.0	7.5
1080p25	1.3	2.5	3.8	5.0	6.2
1080p23.98\24	1.2	2.4	3.6	4.8	6.0
1080PsF29.97\30	1.5	3.0	4.5	6.0	7.5
1080PsF25	1.3	2.5	3.8	5.0	6.2
1080PsF23.98\24	1.2	2.4	3.6	4.8	6.0
1080i59.94\60	3.0	6.0	9.0	12.0	15.0
1080i50	2.5	4.5	7.5	10.0	12.5
720p59.94\60	1.3	2.6	4.0	5.3	6.7
720p50	1.1	2.2	3.4	4.4	5.6
625i50	0.5	1.0	1.5	2.0	2.5
525i59.94	0.5	1.0	1.5	2.0	2.5

Ki Pro GO2 Dimensions

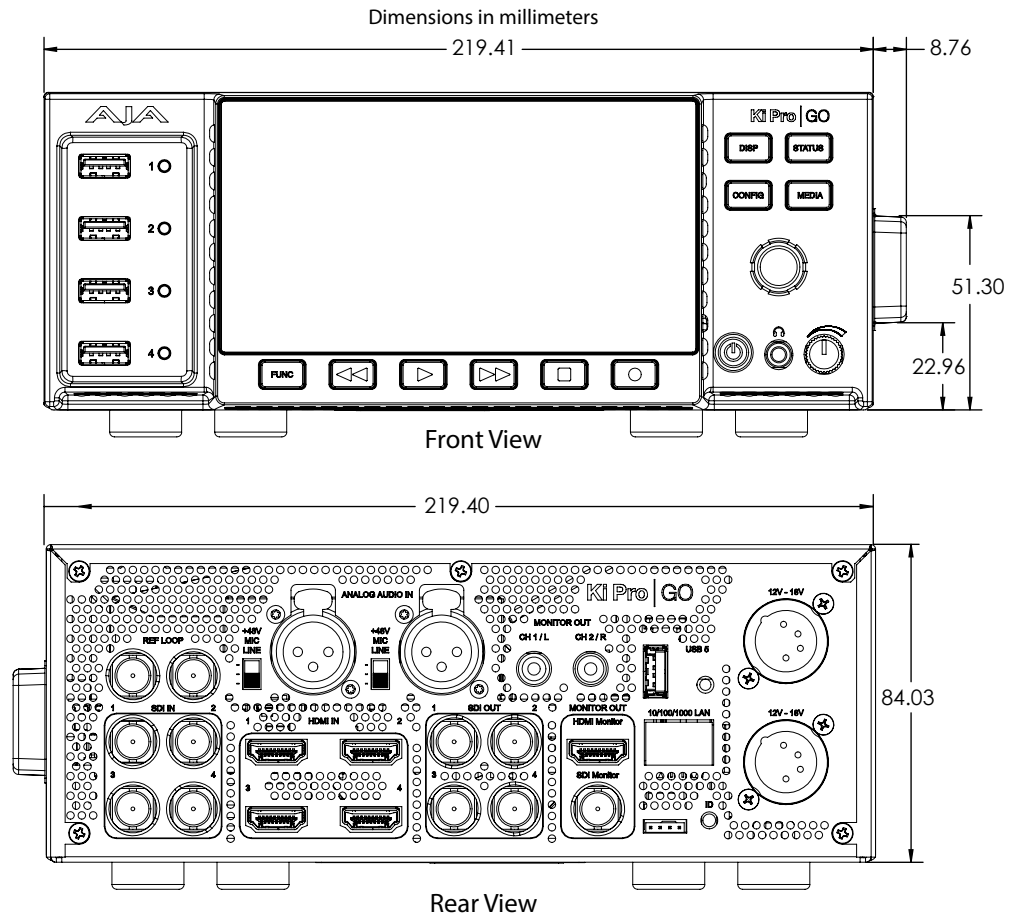

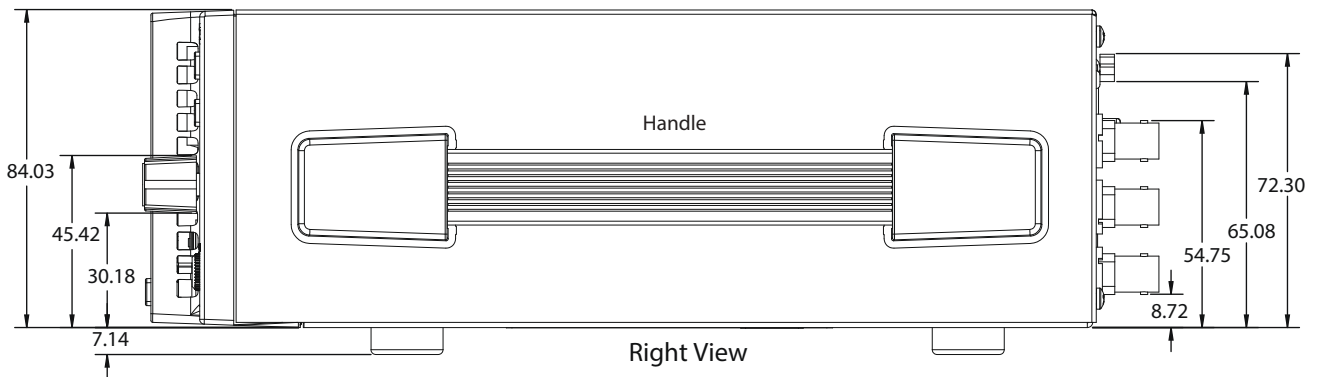
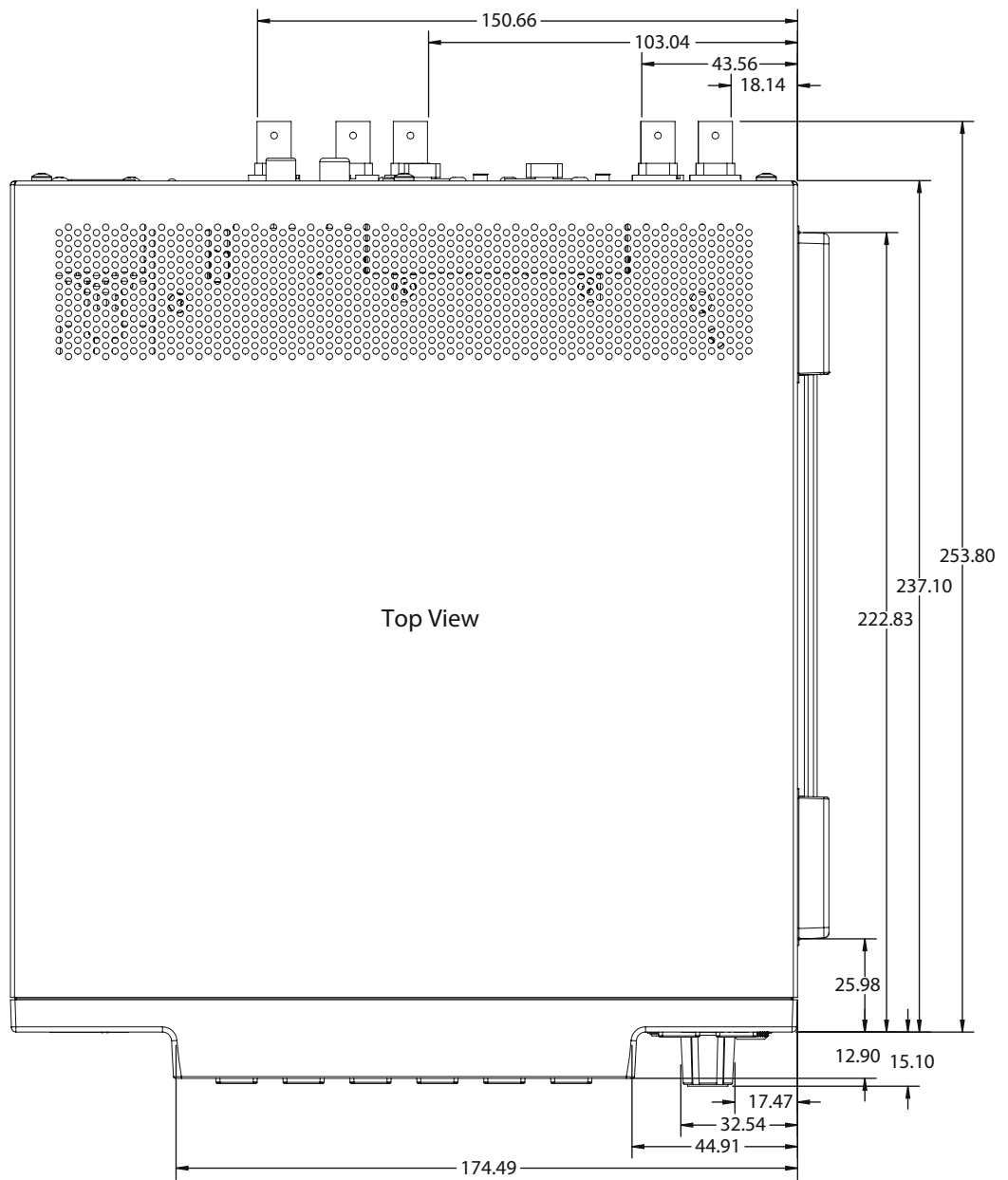

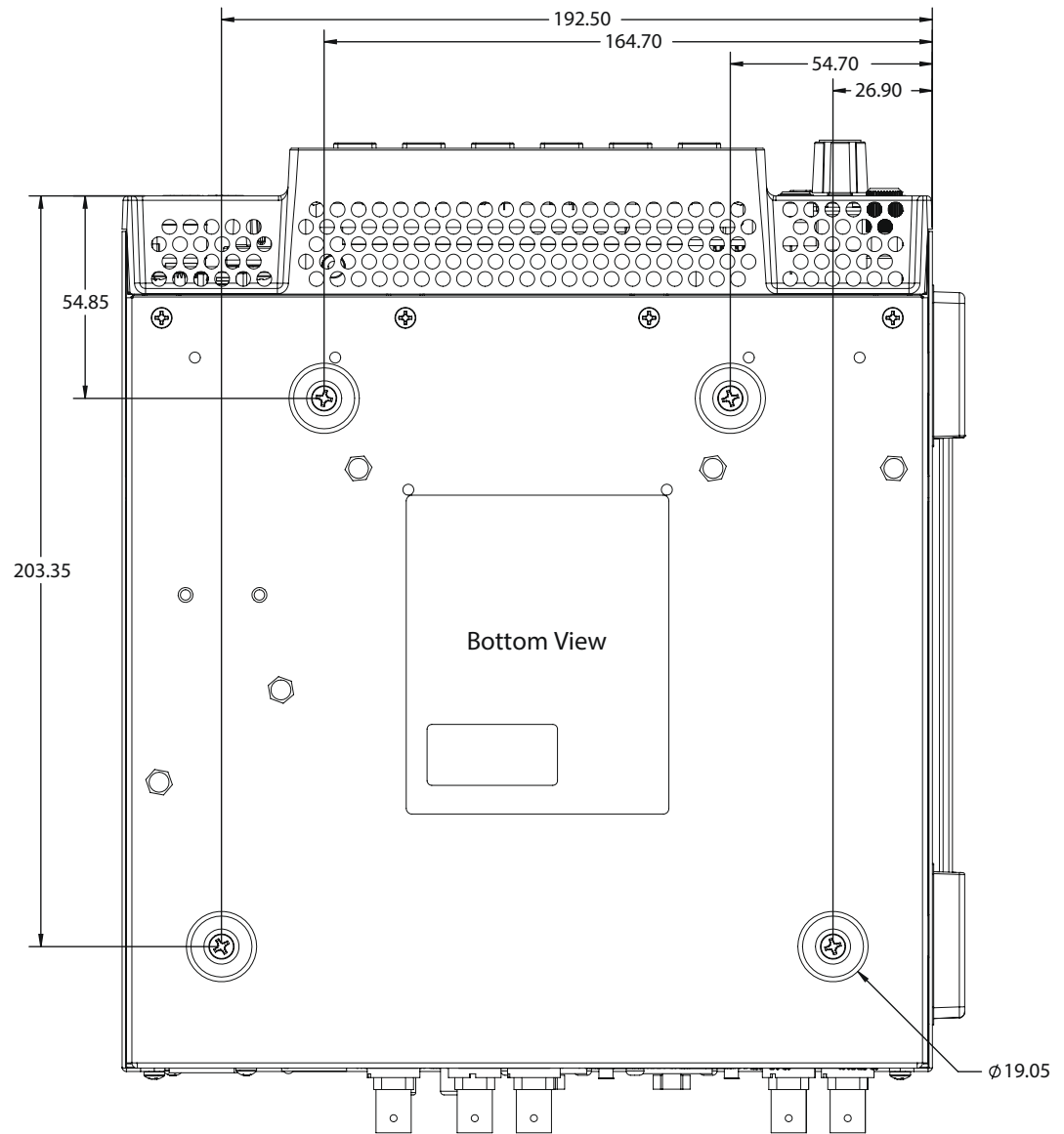

Appendix B – Safety and Compliance

Federal Communications Commission (FCC) Compliance Notices

Class A Interference Statement

This equipment has been tested and found to comply with the limits for a Class A digital device, pursuant to Part 15, Subpart B of the FCC Rules. These limits are designed to provide reasonable protection against harmful interference in a residential installation. This equipment generates, uses, and can radiate radio frequency energy and, if not installed and used in accordance with the instructions, may cause harmful interference to radio communications. However, there is no guarantee that interference will not occur in a particular installation. If this equipment does cause harmful interference to radio or television reception, which can be determined by turning the equipment off and on, the user is encouraged to try to correct the interference by one or more of the following measures:

- Reorient or relocate the receiving antenna.
- Increase the separation between the equipment and receiver.
- Connect the equipment into an outlet on a circuit different from that to which the receiver is connected.
- Consult the dealer or an experienced radio/TV technician for help.

FCC Caution

This device complies with Part 15 of the FCC Rules. Operation is subject to the following two conditions: (1) This device may not cause harmful interference, and (2) this device must accept any interference received, including interference that may cause undesired operation.

Canadian ICES Statement

Canadian Department of Communications Radio Interference Regulations

This digital apparatus does not exceed the Class A limits for radio-noise emissions from a digital apparatus as set out in the Radio Interference Regulations of the Canadian Department of Communications. This Class A digital apparatus complies with Canadian ICES-003.

Règlement sur le brouillage radioélectrique du ministère des Communications

Cet appareil numérique respecte les limites de bruits radioélectriques visant les appareils numériques de classe A prescrites dans le Règlement sur le brouillage radioélectrique du ministère des Communications du Canada. Cet appareil numérique de la Classe A est conforme à la norme NMB-003 du Canada.

European Union, European Free Trade Association (EFTA) and United Kingdom Regulatory Compliance

This equipment may be operated in the countries that comprise the member countries of the European Union, European Free Trade Association and the United Kingdom. These countries, listed in the following paragraph, are referred to as The European Community throughout this document:

AUSTRIA, BELGIUM, BULGARIA, CROATIA, CZECH REPUBLIC, DENMARK, ESTONIA, FINLAND, FRANCE, GERMANY, GREECE, HUNGARY, ICELAND, IRELAND, ITALY, LATVIA, LIECHTENSTEIN, LITHUANIA, LUXEMBOURG, MALTA, NETHERLANDS, NORWAY, POLAND, PORTUGAL, REPUBLIC OF CYPRUS, ROMANIA, SLOVAK REPUBLIC, SLOVENIA, SPAIN, SWEDEN, SWITZERLAND, UNITED KINGDOM

Declaration of Conformity

Marking by these symbols indicates compliance with the Essential Requirements of the EMC Directive of the European Union 2014/30/EU.



This equipment meets the following conformance standards:

Safety

EN 62368-1: 2014 + A11 (T-Mark License)

IEC 62368-1: 2014 (CB Scheme Certificate)

Emissions

EN 55032: 2015 + A11: 2020, CISPR 32: 2015

EN 61000-3-2: 2014, EN 61000-3-3: 2013

Immunity

EN 55035: 2017 + A11: 2020, EN 61000-4-2: 2009, EN 61000-4-3: 2006+ A1: 2008 + A2: 2010, EN 61000-4-4: 2012, EN 61000-4-5: 2014/A1: 2017, EN 61000-4-6: 2014, EN 61000-4-8: 2010, EN 61000-4-11: 2020

Environments: E2, E3 and E4

The product is also licensed for additional country specific standards as required for the International Marketplace.

Laser

EN 60825-1: 2014+A11 and EN 60825-2: 2004+A1+A2,

CDRH Compliant Class 1 (TUV Cert No. R50408760)

Also Licensed for Standards: FDA 21 CFR 1040.10 and 1040.11

NOTE: To meet compliance with the ESD regulations for application of the CE mark, AJA recommends the use of the following USB drives:

- SanDisk Ultra Flair USB 3.0 Flash Drives. Model number SDCZ73-016G-A

The product is also licensed for additional country specific standards as required for the International Marketplace.



Warning! This is a Class A product. In a domestic environment, this product may cause radio interference, in which case, the user may be required to take appropriate measures.

Achtung! Dieses ist ein Gerät der Funkstörgrenzwertklasse A. In Wohnbereichen können bei Betrieb dieses Gerätes Rundfunkstörungen auftreten, in welchen Fällen der Benutzer für entsprechende Gegenmaßnahmen verantwortlich ist.

Attention! Ceci est un produit de Classe A. Dans un environnement domestique, ce produit risque de créer des interférences radioélectriques, il appartiendra alors à l'utilisateur de prendre les mesures spécifiques appropriées.

Recycling Notice



This symbol on the product or its packaging indicates that this product must not be disposed of with your other household waste. Instead, it is your responsibility to dispose of your waste equipment by handing it over to a designated collection point for the recycling of waste electrical and electronic equipment. The separate collection and recycling of your waste equipment at the time of disposal will help conserve natural resources and ensure that it is recycled in a manner that protects human health and the environment. For more information about where you can drop off your waste for recycling, please contact your local authority, or where you purchased your product.

Korea KCC Compliance Statement

사용자 안내문

이 기기는 업무용 환경에서 사용할 목적으로 적합성평가를 받은 기기로서 가정용 환경에서 사용하는 경우 전파간섭의 우려가 있습니다.

Taiwan Compliance Statement

警告使用者：
這是甲類的資訊產品，在居住的環境中使用時，可能會造成射頻干擾，在這種情況下，使用者會被要求採取某些適當的對策。

This is a Class A product based on the standard of the Bureau of Standards, Metrology and Inspection (BSMI) CNS 13438, Class A. In a domestic environment this product may cause radio interference in which case the user may be required to take adequate measures.

Japan Compliance Statement

この装置は、クラスA情報技術装置です。この装置を家庭環境で使用すると電波妨害を引き起こすことがあります。この場合には使用者が適切な対策を講ずるよう要求されることがあります。 VCCI-A

This is a Class A product based on the standard of the VCCI Council (VCCI 32: 2016). If this equipment is used in a domestic environment, radio interference may occur, in which case, the user may be required to take corrective actions.

Chinese Compliance Statement

This product has been tested to the following Chinese standards:

GB 17625.1-2022, GB 4943.1-2022, GB/T 9254.1-2021

This is to certify that the above mentioned product(s) complies with the requirements of certification rules of CQC12-045800-2022 under certificate number CQC2016010805842057.

Translated Warning and Caution Messages

The following caution statements, warning conventions, and warning messages apply to this product and manual.



Warning Symbol



Hazard Symbol



Caution Symbol

Before Operation Please Read These Instructions



Warning! Read and follow all warning notices and instructions marked on the product or included in the documentation.

Avertissement! Lisez et conformez-vous à tous les avis et instructions d'avertissement indiqués sur le produit ou dans la documentation.

Warnung! Lesen und befolgen Sie die Warnhinweise und Anweisungen, die auf dem Produkt angebracht oder in der Dokumentation enthalten sind.

¡Advertencia! Lea y siga todas las instrucciones y advertencias marcadas en el producto o incluidas en la documentación.

Aviso! Leia e siga todos os avisos e instruções assinalados no produto ou incluídos na documentação.

Avviso! Leggere e seguire tutti gli avvisi e le istruzioni presenti sul prodotto o inclusi nella documentazione.



Warning! Do not use this device near water and clean only with a dry cloth.

Avertissement! N'utilisez pas cet appareil près de l'eau et nettoyez-le seulement avec un tissu sec.

Warnung! Das Gerät nicht in der Nähe von Wasser verwenden und nur mit einem trockenen Tuch säubern.

¡Advertencia! No utilice este dispositivo cerca del agua y límpielo solamente con un paño seco.

Aviso! Não utilize este dispositivo perto da água e limpe-o somente com um pano seco.

Avviso! Non utilizzare questo dispositivo vicino all'acqua e pulirlo soltanto con un panno asciutto.



Warning! Do not block any ventilation openings. Install in accordance with the manufacturer's instructions.

Avertissement! Ne bloquez aucune ouverture de ventilation. Suivez les instructions du fabricant lors de l'installation.

Warnung! Die Lüftungsöffnungen dürfen nicht blockiert werden. Nur gemäß den Anweisungen des Herstellers installieren.

¡Advertencia! No bloquee ninguna de las aberturas de la ventilación. Instale de acuerdo con las instrucciones del fabricante.

Aviso! Não obstrua nenhuma das aberturas de ventilação. Instale de acordo com as instruções do fabricante.

Avviso! Non ostruire le aperture di ventilazione. Installare in conformità con le istruzioni del fornitore.



Warning! Do not install near any heat sources such as radiators, heat registers, stoves, or other apparatus (including amplifiers) that produce heat.

Avertissement! N'installez pas l'appareil près d'une source de chaleur telle que des radiateurs, des bouches d'air de chauffage, des fourneaux ou d'autres appareils (amplificateurs compris) qui produisent de la chaleur.

Warnung! Nicht in der Nähe von Wärmequellen wie Heizkörpern, Heizregistern, Öfen oder anderen Wärme erzeugenden Geräten (einschließlich Verstärkern) aufstellen.

¡Advertencia! No instale cerca de fuentes de calor tales como radiadores, registros de calor, estufas u otros aparatos (incluidos amplificadores) que generan calor.

Aviso! Não instale perto de nenhuma fonte de calor tal como radiadores, saídas de calor, fogões ou outros aparelhos (incluindo amplificadores) que produzam calor.

Avviso! Non installare vicino a fonti di calore come termosifoni, diffusori di aria calda, stufe o altri apparecchi (amplificatori compresi) che emettono calore.



Warning! Unplug this device during lightning storms or when unused for long periods of time.

Avertissement! Débranchez cet appareil pendant les orages avec éclairs ou s'il est inutilisé pendant de longues périodes.

Warnung! Das Gerät ist bei Gewitterstürmen oder wenn es über lange Zeiträume ungenutzt bleibt vom Netz zu trennen.

¡Advertencia! Desenchufe este dispositivo durante tormentas eléctricas o cuando no se lo utilice por largos periodos del tiempo.

Aviso! Desconecte este dispositivo da tomada durante trovoadas ou quando não é utilizado durante longos períodos de tempo.

Avviso! Utilizzare soltanto i collegamenti e gli accessori specificati e/o venduti dal produttore, quali il treppiedi e l'esoscheletro.



Warning! Do not open the chassis. There are no user-serviceable parts inside.

Opening the chassis will void the warranty unless performed by an AJA service center or licensed facility.

Avertissement! Ne pas ouvrir le châssis. Aucun élément à l'intérieur du châssis ne peut être réparé par l'utilisateur. La garantie sera annulée si le châssis est ouvert par toute autre personne qu'un technicien d'un centre de service ou d'un établissement agréé AJA.

Warnung! Öffnen Sie das Gehäuse nicht. Keine der Geräteteile können vom Benutzer gewartet werden. Durch das Öffnen des Gehäuses wird die Garantie hinfällig, es sei denn, solche Wartungsarbeiten werden in einem AJA-Service-Center oder einem lizenzierten Betrieb vorgenommen.

¡Advertencia! No abra el chasis. El interior no contiene piezas reparables por el usuario. El abrir el chasis anulará la garantía a menos que se lo haga en un centro de servicio AJA o en un local autorizado.

Advertência! Não abra o chassi. Não há internamente nenhuma peça que permita manutenção pelo usuário. Abrir o chassi anula a garantia, a menos que a abertura seja realizada por uma central de serviços da AJA ou por um local autorizado.

Avvertenza! Non aprire lo chassis. All'interno non ci sono parti riparabili dall'utente. L'apertura dello chassis invaliderà la garanzia se non viene effettuata da un centro ufficiale o autorizzato AJA.



Warning! Only use attachments and accessories specified and/or sold by the manufacturer.

Avertissement! Utilisez seulement les attaches et accessoires spécifiés et/ou vendus par le fabricant.

Warnung! Verwenden Sie nur Zusatzgeräte und Zubehör angegeben und / oder verkauft wurde durch den Hersteller.

¡Advertencia! Utilice solamente los accesorios y conexiones especificados y/o vendidos por el fabricante.

Aviso! Utilize apenas equipamentos/acessórios especificados e/ou vendidos pelo fabricante.

Avviso! Utilizzare soltanto i collegamenti e gli accessori specificati e/o venduti dal produttore.



Warning! Refer all servicing to qualified service personnel. Servicing is required when the device has been damaged in any way, such as power-supply cord or plug is damaged, liquid has been spilled or objects have fallen into the device, the device has been exposed to rain or moisture, does not operate normally, or has been dropped.

Avertissement! Référez-vous au personnel de service qualifié pour tout entretien. L'entretien est exigé quand l'appareil a été endommagé de quelque manière que ce soit, par exemple lorsque le cordon d'alimentation ou la prise sont endommagés, que du liquide a été versé ou des objets sont tombés dans l'appareil, que l'appareil a été exposé à la pluie ou à l'humidité, ne fonctionne pas normalement ou est tombé.

Warnung! Das Gerät sollte nur von qualifizierten Fachkräften gewartet werden. Eine Wartung ist fällig, wenn das Gerät in irgendeiner Weise beschädigt wurde, wie bei beschädigtem Netzkabel oder Netzstecker, falls Flüssigkeiten oder Objekte in das Gerät gelangen, das Gerät Regen oder Feuchtigkeit ausgesetzt wurde, nicht ordnungsgemäß funktioniert oder fallen gelassen wurde.

¡Advertencia! Consulte al personal calificado por cuestiones de reparación. El servicio de reparación se requiere cuando el dispositivo ha recibido cualquier tipo de daño, por ejemplo cable o espigas dañadas, se ha derramado líquido o se han caído objetos dentro del dispositivo, el dispositivo ha sido expuesto a la lluvia o humedad, o no funciona de modo normal, o se ha caído.

Aviso! Remeta todos os serviços de manutenção para o pessoal de assistência qualificado. A prestação de serviços de manutenção é exigida quando o dispositivo foi danificado mediante qualquer forma, como um cabo de alimentação ou ficha que se encontra danificado/a, quando foi derramado líquido ou caíram objectos sobre o dispositivo, quando o dispositivo foi exposto à chuva ou à humidade, quando não funciona normalmente ou quando foi deixado cair.

Avviso! Fare riferimento al personale qualificato per tutti gli interventi di assistenza. L'assistenza è necessaria quando il dispositivo è stato danneggiato in qualche modo, ad esempio se il cavo di alimentazione o la spina sono danneggiati, è stato rovesciato del liquido è stato rovesciato o qualche oggetto è caduto nel dispositivo, il dispositivo è stato esposto a pioggia o umidità, non funziona correttamente o è caduto.



Warning! Do not defeat the safety purpose of the polarized or grounding-type plug. A polarized plug has two blades with one wider than the other. A grounding type plug has two blades and a third grounding prong. The wide blade or the third prong are provided for your safety. If the provided plug does not fit into your outlet, consult an electrician for replacement of the obsolete outlet.

Avertissement! La sécurité de la prise polarisée ou de la prise de type mise à la terre ne doit en aucun cas être empêchée de fonctionner. Une prise polarisée a deux broches, l'une étant plus large que l'autre. Une prise de type mise à la terre a deux broches et une troisième broche pour la mise à la terre. La broche large ou la troisième broche sont fournies pour votre sécurité. Si la prise fournie ne s'insère pas dans votre prise femelle, consultez un électricien pour le remplacement de la prise femelle obsolète.

Warnung! Der Sicherheitszweck des gepolten bzw. Schukosteckers ist zu berücksichtigen. Ein gepolter Stecker verfügt über zwei Pole, von denen einer breiter als der andere ist. Ein Schukostecker verfügt neben den zwei Polen noch über einen dritten Pol zur Erdung. Der breite Pol bzw. der Erdungspol dienen der Sicherheit. Wenn der zur Verfügung gestellte Stecker nicht in Ihren Anschluss passt, konsultieren Sie einen Elektriker, um den veralteten Anschluss zu ersetzen.

¡Advertencia! No eche por tierra la finalidad del tipo de enchufe polarizado con conexión a tierra. Un enchufe polarizado tiene dos espigas, una más ancha que la otra. Un enchufe con conexión a tierra tiene dos espigas iguales y una tercera espiga que sirve para la conexión a tierra. La espiga ancha, o la tercera espiga, sirven para su seguridad. Si el enchufe suministrado no encaja en el tomacorriente, consulte con un electricista para reemplazar el tomacorriente obsoleto.

Aviso! Não anule a finalidade da segurança da ficha polarizada ou do tipo ligação terra. Uma ficha polarizada tem duas lâminas sendo uma mais larga do que a outra. Uma ficha do tipo de ligação à terra tem duas lâminas e um terceiro terminal de ligação à terra. A lâmina larga ou o terceiro terminal são fornecidos para sua segurança. Se a ficha fornecida não couber na sua tomada, consulte um electricista para a substituição da tomada obsoleta.

Avviso! Non compromettere la sicurezza della spina polarizzata o con messa a terra. Una spina polarizzata ha due spinotti, di cui uno più largo. Una spina con messa a terra ha due spinotti e un terzo polo per la messa a terra. Lo spinotto largo o il terzo polo sono forniti per motivi di sicurezza. Se la spina fornita non si inserisce nella presa di corrente, contattare un elettricista per la sostituzione della presa obsoleta.



Warning! Since the Mains plug is used as the disconnection for the device, it must remain readily accessible and operable.

Avertissement! Puisque la prise principale est utilisée pour débrancher l'appareil, elle doit rester aisément accessible et fonctionnelle.

Warnung! Da der Netzstecker als Trennvorrichtung dient, muss er stets zugänglich und funktionsfähig sein.

¡Advertencia! Puesto que el enchufe de la red eléctrica se utiliza como dispositivo de desconexión, debe seguir siendo fácilmente accesible y operable.

Aviso! Dado que a ficha principal é utilizada como a desconexão para o dispositivo, esta deve manter-se prontamente acessível e funcional.

Avviso! Poiché il cavo di alimentazione viene usato come dispositivo di sconnessione, deve rimanere prontamente accessibile e operabile.



Warning! Protect the power cord from being walked on or pinched particularly at plugs, convenience receptacles, and the point where they exit from the device.

Avertissement! Protégez le cordon d'alimentation pour que l'on ne marche pas dessus ou qu'on le pince, en particulier au niveau des prises mâles, des réceptacles de convenance, et à l'endroit où il sort de l'appareil.

Warnung! Vermeiden Sie, dass auf das Netzkabel getreten oder das Kabel geknickt wird, insbesondere an den Steckern, den Steckdosen und am Kabelausgang am Gerät.

¡Advertencia! Proteja el cable de energía para que no se le pise ni apriete, en especial cerca del enchufe, los receptáculos de conveniencia y el punto del que salen del equipo.

Aviso! Proteja o cabo de alimentação de ser pisado ou de ser comprimido particularmente nas fichas, em tomadas de parede de conveniência e no ponto de onde sai do dispositivo.

Avviso! Proteggere il cavo di alimentazione in modo che nessuno ci cammini sopra e che non venga schiacciato soprattutto in corrispondenza delle spine e del punto in cui esce dal dispositivo.



Warning! Disconnect the external AC power supply line cord(s) from the mains power before moving the unit.

Avertissement! Retirez le ou les cordons d'alimentation en CA de la source d'alimentation principale lorsque vous déplacez l'appareil.

Warnung! Trennen Sie die Wechselstrom-Versorgungskabel vom Netzstrom, bevor Sie das Gerät verschieben.

¡Advertencia! Cuando mueva la unidad desenchufe de la red eléctrica el/los cable(s) de la fuente de alimentación CA tipo brick.

Advertência! Remova os cabos CA de alimentação brick da rede elétrica ao mover a unidade.

Avvertenza! Scollegare il cavo dell'alimentatore quando si sposta l'unità.



Caution! This device contains a lithium battery. If you ever dispose of this device, ensure you follow local regulations for safe disposal. The lithium battery shall not be exposed to excessive heat, such as sunshine or fire.

Attention ! Cet appareil comporte une batterie au lithium. Si jamais vous souhaitez vous débarrasser du cet appareil veillez à le faire en toute sécurité et dans le respect de la réglementation locale. La batterie au lithium ne doit pas être exposée à une chaleur excessive, qu'il s'agisse du soleil ou d'un feu.

Vorsicht! Dieses Gerät enthält eine Lithiumbatterie. Wenn der Dieses Gerät jemals entsorgt wird, müssen die örtlichen Regeln bezüglich sicherer Entsorgung befolgt werden. Die Lithiumbatterie darf keiner übermäßigen Wärme ausgesetzt werden, wie z.B. Sonneneinstrahlung oder Feuer.

Attenzione! Este dispositivo contiene una batteria al litio. Se si elimina il este dispositivo seguire scrupolosamente le norme locali concernenti lo smaltimento in sicurezza. La batteria al litio non deve essere esposta a calore eccessivo, come quello della luce solare diretta o del fuoco.

Cuidado! Este dispositivo contém uma bateria de lítio. Ao eliminar o este dispositivo, certifique-se que o faz seguindo as regulamentações locais para uma eliminação segura. A bateria de lítio não deverá ser exposta a calor excessivo, como por exemplo, luz do sol ou lume.

¡Cuidado! Este dispositivo contiene una batería de litio. Si alguna vez decides desechar este dispositivo, asegúrate de seguir las regulaciones locales para una eliminación segura. La batería de litio no debe estar expuesta a calor excesivo, como la luz solar o el fuego.



Warning! This device has no user-serviceable parts. To remove power from the unit, remove the 4-pin XLR power connector to ensure disconnection. Refer all servicing to qualified service personnel. Servicing is required when the device has been damaged in any way, such as power-supply cord or plug is damaged, liquid has been spilled or objects have fallen into the device, the device has been exposed to rain or moisture, does not operate normally, or has been dropped.

Avertissement! Cet appareil ne contient aucune pièce réparable par l'utilisateur. Pour mettre l'unité hors tension, déconnectez-la en débranchant le connecteur électrique XLR à quatre broches. Confiez l'entretien à du personnel de maintenance qualifié. Il faut effectuer une révision lorsque l'appareil a été endommagé de quelque façon que ce soit, par exemple lorsque le câble d'alimentation ou le connecteur est endommagé, lorsque du liquide a été renversé ou que des objets sont tombés sur l'appareil, lorsque ce dernier a été exposé à la pluie ou à l'humidité, lorsqu'il ne fonctionne pas normalement ou lorsqu'il a subi une chute.

Achtung! Dieses Gerät enthält keine vom Benutzer zu wartenden Teile. Um die Einheit stromlos zu schalten, den 4-Stift XLR Stromanschluss abziehen, um Abschaltung sicherzustellen. Wartung darf nur von qualifiziertem Wartungspersonal vorgenommen werden. Wartung ist erforderlich, falls das Gerät auf irgendeine Weise beschädigt worden ist, z.B. wenn das Netzkabel oder der Stecker beschädigt wurde, Flüssigkeit in das Gerät verschüttet wurde oder Gegenstände in das Gerät gefallen sind, das Gerät Regen oder Feuchtigkeit ausgesetzt wurde, es nicht auf normale Weise funktioniert oder fallengelassen wurde.

Avvertenza! Questo dispositivo non contiene parti riparabili dall'utente. Per spegnere il dispositivo, rimuovere il connettore di alimentazione XLR a 4 contatti. Per qualsiasi intervento rivolgersi a personale di manutenzione qualificato. È necessario intervenire sul dispositivo se questo è stato danneggiato in un modo qualsiasi, ad esempio la spina o il cavo di alimentazione ha subito danni, è stato versato liquido o sono caduti oggetti sul dispositivo oppure se il dispositivo è stato esposto alla pioggia o a umidità, non funziona normalmente o è caduto.

Avvertenza! In alcuni Paesi, potrebbe essere necessario fornire il corretto cavo di alimentazione. Usare solo un cavo per corrente alternata a norma IEC 320 tipo C-13 con corrente e tensione nominali di almeno 10 A a 250 V e certificato per il Paese in cui sarà usato.

Aviso! Este dispositivo não possui peças reparáveis pelo usuário. Para retirar a energia da unidade, retire o conector de energia XLR de 4 pinos, para assegurar a desconexão. Indique toda a manutenção para pessoal de manutenção qualificado. A manutenção é necessária quando o dispositivo tiver sido danificado sob qualquer forma, como, por exemplo, se o cabo eléctrico ou de alimentação foi danificado, líquido foi derramado ou objectos caíram sobre o dispositivo, o dispositivo foi exposto a chuva ou humidade, não funciona normalmente ou se tiver caído.

¡Advertencia! Este dispositivo no contiene piezas que el usuario pueda reparar. Para eliminar el potencia de la unidad, retire el conector de alimentación de 4 pines XLR para asegurar la desconexión. Diríjase a un personal calificado de servicio para toda reparación. Se requiere servicio cuando el aparato ha sido dañado de cualquier forma, por ejemplo el cable de alimentación o el enchufe está dañado, se ha derramado líquido u objetos han caído en el dispositivo, el dispositivo ha sido expuesto a la lluvia o humedad, no funciona normalmente o se ha caído.

3 Year Warranty and Liability Information

Limited Warranty on Hardware

AJA Video Systems, Inc. (AJA Video) warrants that the hardware product, not including storage modules or software components, will be free from defects in materials and workmanship for a period of three years from the date of purchase. AJA Video warrants that the storage modules provided as part of the hardware product will be free from defects in materials and workmanship for a period of one year from the date of purchase. AJA Video provides a separate software warranty as part of the license agreement applicable to software components.

If the Customer brings a valid claim under this limited warranty for a hardware product or storage module (hereafter, a "product") during the applicable warranty period, AJA Video will, at its sole option and as the Customer's sole remedy for breach of the above warranty, provide one of the following remedies:

- Repair or facilitate the repair the product within a reasonable period of time, free of charge for parts and labor.
- Replace the product with a direct replacement or with a product that performs substantially the same function as the original product.
- Issue a refund of the original purchase price less depreciation to be determined based on the age of the product at the time remedy is sought under this limited warranty.

To obtain service under this warranty, the Customer must notify AJA Video of the defect before expiration of the warranty period and make suitable arrangements for the performance of service by contacting AJA Video support through the channels set forth on the support contacts web page at <https://www.aja.com/support>.

Except as stated, the Customer shall bear all shipping, packing, insurance and other costs, excluding parts and labor, to effectuate repair. Customer shall pack and ship the defective product to a service center designated by AJA Video, with shipping charges prepaid. AJA Video shall pay to return the product to Customer, but only if to a location within the country in which the AJA Video service center is located. SOME JURISDICTIONS DO NOT ALLOW THE EXCLUSION OF IMPLIED WARRANTIES OR LIMITATIONS ON APPLICABLE STATUTORY RIGHTS OF A CONSUMER, SO SOME OR ALL OF THE TERMS OF THIS PARAGRAPH MAY NOT APPLY TO YOU.

Limitation of Liability

Under no circumstances shall AJA video BE LIABLE IN ANY WAY FOR ANY LOST, CORRUPTED OR DESTROYED DATA, FOOTAGE OR WORK, OR FOR ANY OTHER INDIRECT, SPECIAL, INCIDENTAL OR CONSEQUENTIAL DAMAGES OR LOST PROFITS, OR FOR ANY THIRD PARTY CLAIM, IN CONNECTION WITH THE PRODUCT, WHETHER RESULTING FROM DEFECTS IN THE PRODUCT, SOFTWARE OR HARDWARE FAILURE, OR ANY OTHER CAUSE WHATSOEVER, EVEN IF AJA VIDEO HAS BEEN ADVISED OF THE POSSIBILITY OF SUCH DAMAGES. AJA VIDEO'S LIABILITY IN CONNECTION WITH THE PRODUCT SHALL UNDER NO CIRCUMSTANCES EXCEED THE PURCHASE PRICE PAID FOR THE PRODUCT. The foregoing limitations apply even if any remedy set forth in this LIMITED WARRANTY fails of its essential purpose. SOME JURISDICTIONS DO NOT ALLOW THE LIMITATION OF LIABILITY FOR PERSONAL INJURY, OR OF INCIDENTAL OR CONSEQUENTIAL DAMAGES, SO SOME OR ALL OF THE TERMS OF THIS PARAGRAPH MAY NOT APPLY TO YOU.

Governing Law and Language; Your Rights

This limited warranty is the only warranty provided by AJA Video on the hardware product. It supersedes all prior or contemporaneous understandings regarding such subject matter. No amendment to or modification of this warranty will be binding unless in writing and signed by AJA Video. The laws of the State of California, USA will govern this warranty and any dispute arising from it. Any translation of this Agreement is intended for convenience and to meet local requirements and in the event of a dispute between the English and any non-English versions, the English version of this warranty will govern. This limited warranty gives you specific legal rights and you may have other rights that vary from jurisdiction to jurisdiction, some of which are noted above.

AJA Software License Agreement

AJA VIDEO SYSTEMS, INC.

THIS IS AN AGREEMENT BETWEEN YOU AND AJA VIDEO SYSTEMS, INC. ("AJA") THAT GOVERNS YOUR USE OF THE SOFTWARE ACCOMPANYING THIS LICENSE (E.G., AS INSTALLED ON THE DEVICE WITH WHICH THIS LICENSE IS PROVIDED).

The "AJA Software" referenced in this Agreement includes all such software, whether made available to you on disk, in read only memory, on any other media or in any other form, and all updates, corrections, enhancements and new versions of such software made available by AJA, together with all related documentation. BY INSTALLING OR USING THE AJA SOFTWARE, YOU ARE AGREEING TO BE BOUND BY THE TERMS OF THIS AGREEMENT. IF YOU DO NOT AGREE TO THE TERMS OF THIS AGREEMENT, DO NOT INSTALL OR USE IT AND, IF APPLICABLE, RETURN THE AJA SOFTWARE TO THE PLACE WHERE YOU OBTAINED IT FOR A REFUND.

1. License Grant. AJA hereby grants you a nonexclusive, personal, non-sublicenseable and limited license to install and use AJA Software on a computer or AJA device. The foregoing license also includes the right to make copies of the AJA Software in machine-readable form for installation and backup purposes only, and provided that each copy you make must include all copyright or other proprietary notices contained on the original.

2. Limitations. You may not decompile, reverse engineer, disassemble, modify, or create derivative works of the AJA Software or any part thereof except to the extent (if any) authorized by applicable law notwithstanding the foregoing restriction. You may not rent, lease, lend, loan, distribute or act as a service bureau or "cloud service" provider with respect to use of the AJA Software or any functionality thereof. THE AJA SOFTWARE IS NOT INTENDED FOR USE IN THE OPERATION OF NUCLEAR FACILITIES, AIRCRAFT NAVIGATION OR COMMUNICATION SYSTEMS, AIR TRAFFIC CONTROL SYSTEMS, LIFE SUPPORT MACHINES OR OTHER EQUIPMENT IN WHICH THE FAILURE OF THE AJA SOFTWARE COULD LEAD TO DEATH, PERSONAL INJURY, OR SEVERE PHYSICAL OR ENVIRONMENTAL DAMAGE.

3. Reservation of Rights. The AJA Software is protected by law, including without limitation copyright law. The AJA Software is licensed, not sold, to you. AJA and its licensors reserve all rights not expressly granted to you by this Agreement. You own the media on which the AJA Software is recorded but AJA and/or AJA's licensor(s) retain ownership of the AJA Software itself. You may not use the AJA Software for any illegal purpose.

4. Transfer. You may make a one-time permanent transfer of all of your license rights to the AJA Software to another person or entity, provided that: (a) you transfer all of the AJA Software, including all its component parts, original media, printed materials and this Agreement; (b) you do not retain any copies of the AJA Software, including any copies stored on a computer or other device; and (c) you transfer the AJA Software subject to this Agreement, and the person or entity receiving the AJA Software accepts the terms and conditions of this Agreement.

5. NFR (Not for Resale) Copies and Add-On Features: Notwithstanding anything to the contrary in this Agreement, (a) AJA Software that is labeled "Not for Resale" or otherwise provided to you on a promotional or demonstration basis may be used only for your demonstration, testing and evaluation purposes and may not be resold or transferred; and (b) AJA may make available certain software components ("Add-On Features") under separate terms and conditions, in which case those separate terms and conditions apply and the Add-On Features are not considered AJA Software under this Agreement.

6. Termination. Your rights in the AJA Software are conditioned on complying with this Agreement, and those rights (together with this Agreement) will terminate automatically, without notice from AJA, if you fail to comply with any term(s) of this Agreement. Upon termination of this Agreement, you must cease all use of the AJA Software and destroy all copies, full or partial, of the AJA Software in your possession or control.

7. Limited Warranty on AJA Software. If you comply with all terms of this Agreement and use the AJA Software in accordance with its documentation, and you install any patches or other updates made available to the AJA Software by AJA, AJA warrants that the AJA Software will perform substantially in accordance with its documentation for a period of ninety (90) days from the date of your original retail purchase. Your exclusive remedy under this warranty will be, at AJA's option, a refund of the purchase

price of the product containing the AJA Software or an update to or replacement of the AJA Software (or applicable component of it). THIS LIMITED WARRANTY AND ANY IMPLIED WARRANTIES ON THE AJA SOFTWARE INCLUDING, BUT NOT LIMITED TO, ANY WARRANTIES OF MERCHANTABILITY, OF SATISFACTORY QUALITY, OR OF FITNESS FOR A PARTICULAR PURPOSE, ARE LIMITED IN DURATION TO NINETY (90) DAYS FROM THE DATE OF ORIGINAL RETAIL PURCHASE. SOME JURISDICTIONS DO NOT ALLOW LIMITATIONS ON HOW LONG A WARRANTY LASTS, SO THE ABOVE LIMITATION MAY NOT APPLY TO YOU. THIS LIMITED WARRANTY GIVES YOU SPECIFIC LEGAL RIGHTS, AND YOU MAY ALSO HAVE OTHER RIGHTS WHICH VARY BY JURISDICTION.

8. Disclaimer of Other Warranties on AJA Software. EXCEPT FOR THE LIMITED WARRANTY ON AJA SOFTWARE SET FORTH ABOVE, AJA AND AJA'S LICENSORS (COLLECTIVELY REFERRED TO AS "AJA" FOR THE PURPOSES OF SECTIONS 8 AND 9) HEREBY DISCLAIM ALL WARRANTIES AND CONDITIONS WITH RESPECT TO THE AJA SOFTWARE, WHETHER EXPRESS, IMPLIED OR STATUTORY, INCLUDING, BUT NOT LIMITED TO, THE IMPLIED WARRANTIES AND/OR CONDITIONS OF MERCHANTABILITY, OF SATISFACTORY QUALITY, OF FITNESS FOR A PARTICULAR PURPOSE, OF ACCURACY, AND OF QUIET ENJOYMENT. FURTHER, AJA DOES NOT MAKE ANY WARRANTY REGARDING NON-INFRINGEMENT OF THIRD PARTY RIGHTS. SUBJECT ONLY TO THE LIMITED WARRANTY SET FORTH IN SECTION 7, YOU EXPRESSLY ACKNOWLEDGE AND AGREE THAT USE OF THE AJA SOFTWARE IS AT YOUR SOLE RISK. AJA DOES NOT WARRANT AGAINST INTERFERENCE WITH YOUR ENJOYMENT OF THE AJA SOFTWARE, THAT THE AJA SOFTWARE WILL MEET YOUR REQUIREMENTS, THAT THE OPERATION OF THE AJA SOFTWARE WILL BE UNINTERRUPTED OR ERROR-FREE, OR THAT DEFECTS IN THE AJA SOFTWARE WILL BE CORRECTED. NO ORAL OR WRITTEN INFORMATION OR ADVICE GIVEN BY AJA OR AN AJA AUTHORIZED REPRESENTATIVE WILL CREATE A WARRANTY. SOME JURISDICTIONS DO NOT ALLOW THE EXCLUSION OF IMPLIED WARRANTIES OR LIMITATIONS ON APPLICABLE STATUTORY RIGHTS OF A CONSUMER, SO SOME OR ALL OF THE TERMS OF THIS PARAGRAPH MAY NOT APPLY TO YOU.

9. Limitation of Liability. TO THE EXTENT NOT PROHIBITED BY LAW, IN NO EVENT WILL AJA BE LIABLE FOR PERSONAL INJURY, OR ANY INCIDENTAL, SPECIAL, INDIRECT OR CONSEQUENTIAL DAMAGES OR LOST PROFITS WHATSOEVER, INCLUDING, WITHOUT LIMITATION, DAMAGES FOR LOSS OF DATA, BUSINESS INTERRUPTION OR ANY OTHER COMMERCIAL DAMAGES OR LOSSES, ARISING OUT OF OR RELATED TO YOUR USE OR INABILITY TO USE THE AJA SOFTWARE, HOWEVER CAUSED, REGARDLESS OF THE THEORY OF LIABILITY (E.G., WHETHER UNDER CONTRACT, TORT OR OTHERWISE) AND EVEN IF AJA HAS BEEN ADVISED OF THE POSSIBILITY OF SUCH DAMAGES. IN NO EVENT WILL AJA'S TOTAL LIABILITY TO YOU FOR ALL DAMAGES (INCLUDING WITHOUT LIMITATION BREACH OF WARRANTY) EXCEED THE AMOUNT OF FIFTY DOLLARS (\$50.00). THE FOREGOING LIMITATIONS WILL APPLY EVEN IF THE ANY REMEDY SET FORTH IN THIS AGREEMENT FAILS OF ITS ESSENTIAL PURPOSE. SOME JURISDICTIONS DO NOT ALLOW THE LIMITATION OF LIABILITY FOR PERSONAL INJURY, OR OF INCIDENTAL OR CONSEQUENTIAL DAMAGES, SO SOME OR ALL OF THE TERMS OF THIS PARAGRAPH MAY NOT APPLY TO YOU.

10. Export Law Assurances. You may not use or otherwise export or reexport the AJA Software except as authorized by United States law and the laws of the jurisdiction in which the AJA Software was obtained. In particular, but without limitation, the AJA Software may not be exported or re-exported (a) into (or to a national or resident of) any U.S. embargoed countries, or (b) to anyone on the U.S. Treasury Department's list of Specially Designated Nationals or the U.S. Department of Commerce Denied Persons List or Entity List or any similar legal designation. By using the AJA Software, you represent and warrant that you are not located in, under control of, or a national or resident of any such country or on any such list.

11. Government End Users. The AJA Software including its documentation is a "Commercial Item", as that term is defined at 48 C.F.R. § 2.101, consisting of "Commercial Computer Software" and "Commercial Computer Software Documentation", as such terms are used in 48 C.F.R. § 12.212 or 48 C.F.R. § 227.7202 (or their successors), as applicable. Consistent with these provisions, the AJA Software is licensed to U.S. Government end users (a) only as a Commercial Item and (b) with only those rights as are granted to all other end users pursuant to this Agreement. Unpublished-rights reserved under the copyright laws of the United States.

12. Controlling Law and Severability. This Agreement will be governed by and construed in accordance with the laws of the State of California, as applied to agreements entered into and to be performed entirely within California between California residents. This Agreement will not be governed by the United Nations

Convention on Contracts for the International Sale of Goods, the application of which is expressly excluded. If for any reason a court of competent jurisdiction finds any provision, or portion thereof, to be unenforceable, the remainder of this Agreement will continue in full force and effect.

13. Complete Agreement; Governing Language. This Agreement constitutes the entire agreement between the parties with respect to the use of the AJA Software licensed hereunder and supersedes all prior or contemporaneous understandings regarding such subject matter. No amendment to or modification of this Agreement will be binding unless in writing and signed by AJA. Any translation of this Agreement is intended for convenience and to meet local requirements and in the event of a dispute between the English and any non-English versions, the English version of this Agreement will govern.

Index

Symbols

3G SDI Level 31

A

AJA Software License Agreement 74
AJA Support 2
Alarm Messages 25
Alarms Tab 24
Analog Audio 32
Analog Audio Inputs 16
Analog Audio Monitor Outputs 16
Audio Input 1 30
Audio Inputs 16
Audio Meter 12
Audio Monitor Outputs 16

B

Backup Recording 27
Bit Depth 59
BNC
 Ref Loop 14

C

CABAC (Context Based Adaptive Binary Arithmetic Coding) 59
CAT Ethernet Cable 20
Channel 1 Backup Rec Dest 39
Channel 1 Clip Name 38
Channel 1 Encode Bit Depth 38
Channel 1 Encode Quality 38
Channel 1 Encode Sampling 38
Channel 1 Primary Rec Dest 39
Chnl/Input Tab 23
Clip
 Cueing 28
 Loop Playback 29
 Playback All 28
 Play Clip 28
 Selection 28
Clip Download 55
Clip Name 37
Clip Number 40
Clip Playback
 Web UI 55
Clip Selection
 Web UI (Mouse Wheel) 44
Config Button 11
CONFIG Menus 29
Config Screen 46
Cue Clip 54
Cueing a Clip 28

D

Date/Time 35
Daylight Savings 35
DC Power 19

Default Gateway 34
Default IP Address 34
DHCP Configuration Procedure 21
DISP Button 10
Domain 41
Domain Password 41
Domain Username 41
Download Clip 55
Drop-Frame Timecode 33

E

Enable Channel 1 29
Encoding Bitrate Table 60
Entropy Encoding 59
Ethernet 16
Ethernet Connector 16
Ethernet Switch 16

F

Factory Fefault
 Settings Not Affected 36
Factory Reset 36
Features 5
FFWD Button 13
File/Encode Tab 23
Firmware Screen
 Web UI 52
Firmware Update Procedure 53
Format All USB Media 42
Formatting Media 6
Formatting USB Media 42
Format USB Port 1-5 Media 42
Front Panel 9
FUNC Button 12
 Front Panel 12
 Web UI 44

G

Genlock Source 32
GOP (Group Of Pictures) 59
GOP Length 59
Group Recording 49
Group Screen 48

H

H.264 38
H.265 38
Handle Installation 17
Hardware Installation 17
HDMI/EDID Override 31
HDMI Inputs 15
HDMI Monitor Channel 30
HDMI Monitor Out 15
Headphone Audio 30
Headphone Jack 13
Headphone Volume Knob 13

I

I-Frame 59
Import Preset 51
Inter/PsF Override 31
IP Address 21, 34
IP Address Default 34
IP Address Type 34
I/P Frame Structure 59

L

LAN Connection 20
LCD Display 10
Loop Play 42
Loop Playback 29
Loss of Video 30

M

MAC Address 34
Media Button 12
Media Formatting 6
Media Menu 36
Media Recording Capacity 28
Media Screen 47
Media Storage 6

N

NAS 6
Network Attached Storage 6
Network Control 19
 Direct Connection 20
 LAN Connection 20
Network Panel 51
Non-Drop Frame Timecode 33

O

Overlay Display 22

P

Packing Contents 17
Playback Media Source 41
Playback Type 42
PLAY Button 13
Playing a Clip
 Front Panel 28
Playlist Refresh 55
Playlists Screen
 Web UI 54
Power
 AC 19
 DC 19
Power Connector 16
Power Connector Pinouts 16
Power ON/OFF Button 13
Power Up 19
Preset
 Import 51

- Recall Factory Setting 51
 - Save 51
 - Preset Export
 - Web UI 51
 - Preset Import 51
 - Web UI 51
 - Preset Save
 - Web UI 51
 - Presets Screen 50
 - Progressive Playback 32
- Q**
- Quick Cueing 54
 - Web UI 54
- R**
- Rear Panel 14
 - Recall Preset 36
 - RECORD Button 13
 - Recording
 - Group 49
 - Recording Backup Clips
 - Front Panel 27
 - Recording Clips
 - Front Panel 27
 - Record Minutes (max) 39
 - Record Type 40
 - Ref Loop 14
 - Refresh Button 55
 - Refresh SMB Directory 55
 - REST API 8
 - REV Button 13
 - Routing Audio
 - Audio Routing 27
 - Routing Video 27
- S**
- Safeboot 53
 - Sampling 59
 - Save Preset 51
 - Screen Brightness 36
 - Screen Dimmer 35
 - SDI Channel Outputs 14
 - SDI Inputs 14
 - SDI Monitor Channel 30
 - SDI Monitor Out 15
 - Select Clip 28
 - Serial Number 36
 - SMB 6
 - SMB Dialect 41
 - SMB Domain 41
 - SMB Domain Password 41
 - SMB Domain Username 41
 - SMB Parameter Editing 48
 - SMB Support 7
 - SMB Tab 24
 - Software Version 36
 - Static IP Connection Procedure 21
 - STATUS Button 11
 - Status Menu Display 23
 - Status Screen 45
 - STOP Button 13
 - Store Preset 36
 - Subnet Mask 34
 - Super Out 31
 - Supported USB Media 7
 - System Name 34
- T**
- Timecode
 - Drop-Frame 33
 - Non-Drop Frame 33
 - Timecode Description 33
 - Timecode In 33
 - Time Code Size 31
 - Timecode Value 33
 - Timecode Value Type 33
 - Time Zone 35
 - Transport Control Buttons 12
- U**
- UI Monitor Channel 30
 - USB Media Port 9
 - USB Port 1 Media Path 40
 - USB Port LED Status Indicator 9
 - User Control Knob 11
- V**
- Video Input 1 29
 - Video Routing 27
 - VU Meter 12
- W**
- Warning Messages 25
 - Web Browser
 - Recommended 43
 - Web Server 19, 43
 - Web UI
 - Alarms Panel 45
 - Clip Playback 55
 - Config Screen 46
 - Firmware Screen 52
 - Media Screen 47
 - Network Panel 51
 - Playlists Screen 54
 - Preset Export Button 51
 - Preset Import Button 51
 - Preset Save Button 51
 - Presets Screen 50
 - Quick Cueing 54
 - Status Screen 45
 - Web UI Status Screen Example 43